



This is a digital copy of a book that was preserved for generations on library shelves before it was carefully scanned by Google as part of a project to make the world's books discoverable online.

It has survived long enough for the copyright to expire and the book to enter the public domain. A public domain book is one that was never subject to copyright or whose legal copyright term has expired. Whether a book is in the public domain may vary country to country. Public domain books are our gateways to the past, representing a wealth of history, culture and knowledge that's often difficult to discover.

Marks, notations and other marginalia present in the original volume will appear in this file - a reminder of this book's long journey from the publisher to a library and finally to you.

### **Usage guidelines**

Google is proud to partner with libraries to digitize public domain materials and make them widely accessible. Public domain books belong to the public and we are merely their custodians. Nevertheless, this work is expensive, so in order to keep providing this resource, we have taken steps to prevent abuse by commercial parties, including placing technical restrictions on automated querying.

We also ask that you:

- + *Make non-commercial use of the files* We designed Google Book Search for use by individuals, and we request that you use these files for personal, non-commercial purposes.
- + *Refrain from automated querying* Do not send automated queries of any sort to Google's system: If you are conducting research on machine translation, optical character recognition or other areas where access to a large amount of text is helpful, please contact us. We encourage the use of public domain materials for these purposes and may be able to help.
- + *Maintain attribution* The Google "watermark" you see on each file is essential for informing people about this project and helping them find additional materials through Google Book Search. Please do not remove it.
- + *Keep it legal* Whatever your use, remember that you are responsible for ensuring that what you are doing is legal. Do not assume that just because we believe a book is in the public domain for users in the United States, that the work is also in the public domain for users in other countries. Whether a book is still in copyright varies from country to country, and we can't offer guidance on whether any specific use of any specific book is allowed. Please do not assume that a book's appearance in Google Book Search means it can be used in any manner anywhere in the world. Copyright infringement liability can be quite severe.

### **About Google Book Search**

Google's mission is to organize the world's information and to make it universally accessible and useful. Google Book Search helps readers discover the world's books while helping authors and publishers reach new audiences. You can search through the full text of this book on the web at <http://books.google.com/>

2 45 0308 9674



LAMC MEDICAL LIBRARY STANFORD

**LANE**

**MEDICAL**



**LIBRARY**

**LEVI COOPER LANE FUND**

*Gift  
Carnegie Institution*



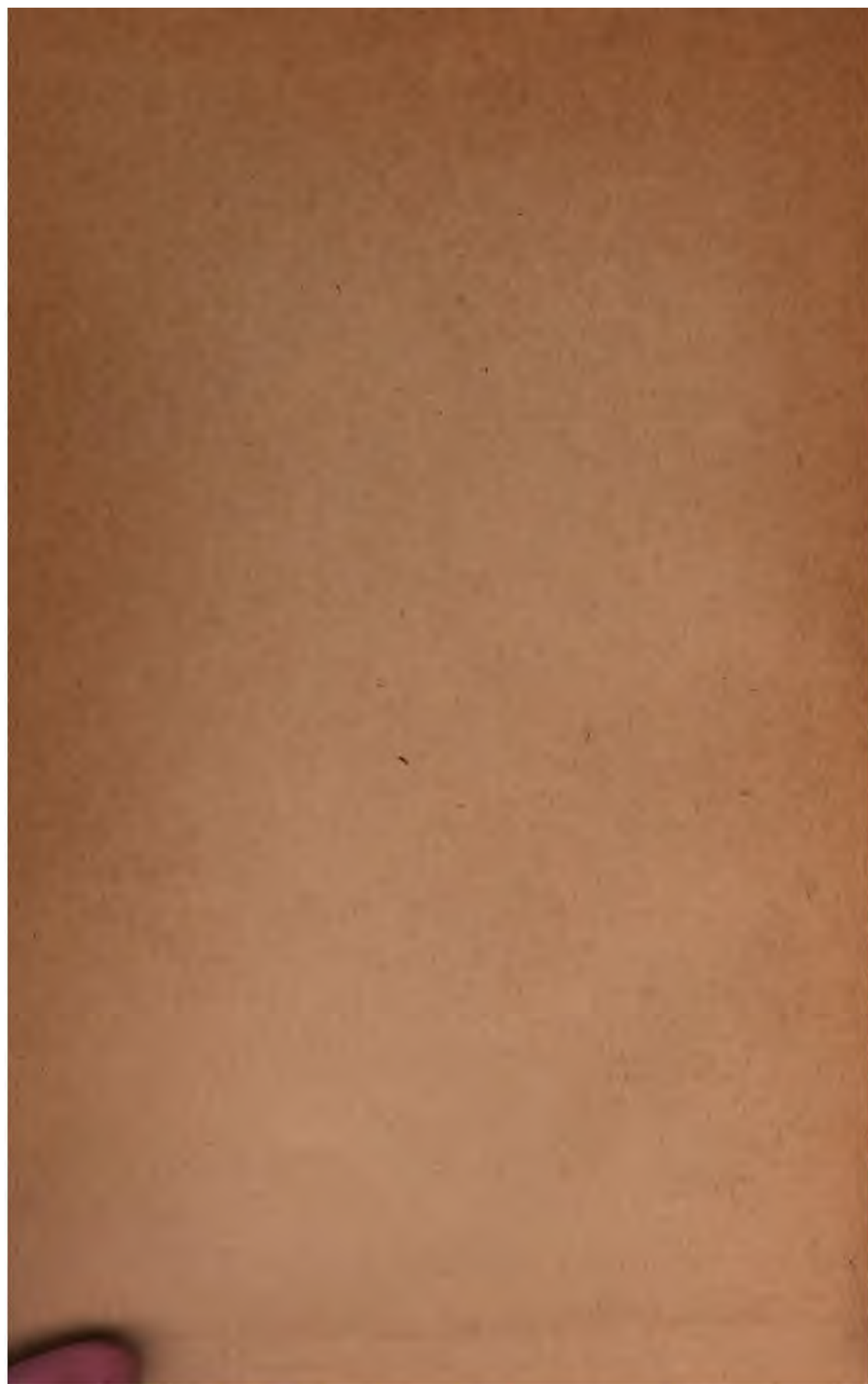

# HYDRATION AND GROWTH

---

By

D. T. MACDOUGAL, PH. D., LL. D.

*Director of the Department of Botanical Research  
Carnegie Institution of Washington*

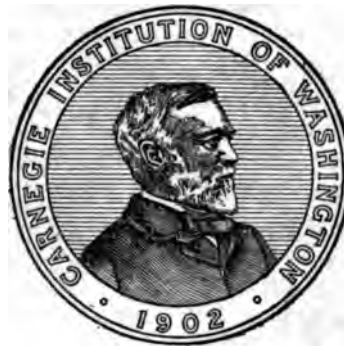

THE CARNEGIE INSTITUTION OF WASHINGTON  
PUBLISHED BY THE CARNEGIE INSTITUTION OF WASHINGTON

PUBLISHED BY THE CARNEGIE INSTITUTION OF WASHINGTON  
WASHINGTON, 1920

**CARNEGIE INSTITUTION OF WASHINGTON**  
**PUBLICATION No. 297**

Y0A981 38A1

**PRESS OF GIBSON BROTHERS, INC.**  
**WASHINGTON, D. C.**

60.291  
1920

## PREFACE.

Three main conceptions concerning growth and its developmental aspects in plants are to be met in the history of physiology in the half century beginning with the researches of Sachs and his school. The first or earliest, that of special stuffs or substances necessary for the initiation of growth and differentiation of various organs, especially for the origination and development of reproductive organs, is now giving way to the modern conclusion that "formative" material as such has no actual existence in fact and no good basis in theory. The present trend of thought leads to the assumption that growth proceeds from and depends upon states or combinations of material or accumulations in connection with living matter rather than upon any special constructive stuff or substance. This may also be held to apply to hormones, vitamins, and other symbolic expressions for combinations of material necessary for initiating and maintaining development, reproduction, or growth.

The second aspect of the subject is that which deals with the incorporation of new material in the cell and its subsequent distention by an osmotic mechanism, upon the basis of researches of Pfeffer and de Vries. The protoplast is dealt with as a sac. The products of the metabolic processes converge in the vacuole, which in consequence becomes the seat of osmotic forces and the center of the mechanism of distention. An important feature of this scheme of operation is an ideal "semi-permeable" membrane, not morphologically identifiable, internal to the cellulose wall or other durable and visible integument. The exploitation of the theory of permeability of this membrane has been carried out in such manner as to place undue emphasis on the action of the external layer of the protoplasm. The basic conception of the diffusion of material into the vacuole remains sound, and the differentiating action of protoplasm by which the increase in the contents of the vacuole sets up an internal pressure expressed as turgidity is undeniable. But the attempt to base all features of water-relations, turgidity, and growth upon the action of solutions has been proved inadequate and has resulted in an obvious neglect of the play of molecular forces in surface tensions, in imbibition, and other activities of matter in a colloidal state.

The third group of inquiries has been directed toward measurement for the purpose of establishing the physical constants of growth. Auxesis or developmental enlargement in living things has been mistakenly dealt with as a unified process, or as a series of successive reactions in studies of temperature effects, by many writers, and coefficients of some apparent validity within a small part of the range within which growth takes place have been found. Growth is a constellation of activities and the rate of one of these dependent on temperature may be the determining one when the particular process forms either the retarding or leading agency. At other times the relative

III



rates of metabolism, respiration, hydration, and diffusion may coincide in such manner as to make possible the application of a simple formula for the effects within a range of 15° or 16° C. The relation of growth to temperature for any plant between 10° and 50° C. is not to be expressed by any simple formula. The same general statement may be made concerning light and other agencies, none of which has received more than a fraction of the amount of attention which has been paid to temperature effects.

The assumption as to the general identity of protoplasm in plants and animals, or even in plants as a group, is one which operates to stifle analytical investigations in a subject of this kind. The relative amounts of proteins, carbohydrates, lipins, and salts in the two groups differ widely. In addition to the capacity of the plant to synthesize carbohydrates, amino-acids, etc., which the animal can not, the respiration and metabolism of the plant are predominantly carbohydrate, while those of the animal are proteinaceous to a much larger extent. It would seem obvious that a protoplasm rich in fats, high in proteins, and permeated with their derivatives would display an imbibition and growth different from living matter in which the base is chiefly the comparatively physiologically inert pentosan groups and which necessarily adsorb the salts and acids in a characteristic manner. The unities or general properties of the protoplasm of widely different organisms do not rest upon the presence or proportion of elements or compounds so much as upon the manner in which the necessary constituents are brought together. This indispensable condition of life is the colloidal state, in which the substances of living matter form a semi-solid or elastic gel consisting of over 90 parts water. The molecules are large, slow-moving, and adhere to form aggregates as contrasted with the separation of molecules in the water of solutions. This colloidal structure may be profitably likened to that of a house or factory, serving simply as the scene of metabolic processes which take place under special conditions of surface tension. The colloidal laboratory may be in the form of an emulsion, a reticulum, a sponge, a crystalline or lamellar structure, with corresponding effects on metabolism, while the products of respiration may in turn cause alterations in the chambers in which it takes place.

The purpose of the present work has been to study growth upon the basis of a more inclusive conception than that usually implied in osmosis. The total absorbing capacity of a cell or mass of protoplasm for water is regarded as being exercised in the process of hydration. The source of energy in growth and swelling is the unsatisfied attraction of molecules, or particles or ions bearing an electrical charge. Substances made up in this manner may unite with definite proportions of water which becomes part of a symmetrical chemical structure, the union being known in classical chemistry as hydration. In addition, however, it is known that such particles may also adsorb and hold in combination additional molecules of water, an action especially

characteristic of swelling in colloids, and the term hydration is used in the present work to include the entire range of action.

The method of study employed has been one in which biocolloids have been compounded from pentosans and proteins in proportions simulating those of the plant, and the total range of swelling of thin plates of this material has been measured by the auxograph which has been developed for this purpose. Series of measurements of such material have been arranged to run parallel with measurements of the unsatisfied hydration capacity of living cell-masses and of dehydrated tissues.

The acids and salts have been employed in concentrations mostly within the range of the biological possibilities. It follows, therefore, that these substances have been applied in solutions in which complete or nearly complete dissociation has taken place.

It was deemed of the greatest importance to traverse a wide field of possibilities, which made the use of simple methods advisable, and solutions have therefore been applied in terms of molar or normal concentration, and acidity has been determined by titrations. The importance of determinations of the acidity, especially of the cell-sap, and its expression in terms of hydrogen- or hydroxyl-ion concentration would be greater in any more critical study of the features of colloidal and protoplasmic action discussed, although it is not to be taken for granted that this is the dominant or determining factor in all cases.

The use of simple methods has served to reveal the general hydration relations of plant protoplasm, the influence of acidity and temperature upon growth and swelling, and to uncover the special effects of the amido-compounds upon hydration and their suggested possibilities in affecting growth.

The significant water-relations of the cell-colloids are not entirely included in direct reactions of the kind mentioned, however. As will be described in Chapter VII, the exigencies of plant life include conditions under which dehydration of the plasmatic colloids may reach such a degree that the nature of some of the sugars in growing cells may be affected, and one of these changes is the conversion of polysaccharids with a low hydration coefficient to pentosans with a high hydration capacity, with the resulting succulency or xerophily of the tissues in which this takes place.

I am indebted to my colleagues for suggestions and assistance both in the experimentation and in the preparation of the manuscript, especially to Dr. H. A. Spoehr, who has collaborated in previous papers and who has given continued cooperation and valuable advice on various phases of the work presented here.

DESERT LABORATORY,  
*Tucson, Arizona, 1919.*

D. T. MACDOUGAL.

## CONTENTS.

	PAGE.
I. Growth and colloidal reactions .....	1
II. Fundamental features of phytocolloids .....	11
III. The constituents of biocolloids which affect hydration and growth .....	27
IV. The effect of salts and acids on biocolloids and cell-masses .....	37
V. The effects of organic acids and their amino compounds on hydration and growth .....	54
VI. Reactions of biocolloids and cell-masses to culture solutions, bog, swamp, and ground water, and other solutions .....	65
VII. Fluctuating or alternating hydration effects. Basis of xerophily and succulence .....	78
VIII. Water deficit, or unsatisfied hydration capacity .....	92
IX. Temperature and the hydration and growth of colloids and of cell-masses .....	110
X. Imbibition and growth of <i>Opuntia</i> .....	128
XI. The hydration reactions and growth of <i>Mesembryanthemum</i> , <i>Helianthus</i> , and <i>Phaseolus</i> .....	145
XII. Water-content, dry weight, and other general considerations .....	161
Literature cited .....	174

# HYDRATION AND GROWTH.

BY D. T. MACDOUGAL.

## I. GROWTH AND COLLOIDAL REACTIONS.

Growth consists in increases in volume of masses of living matter, usually but not invariably accompanied by accretions of material other than water to the colloids of the protoplasm. Auxetic changes in members, organs, or cells of the larger plants may be readily determined by external measurements, and the greater part of the available information concerning the subject has been obtained in this manner. Many generalizations, however, rest upon data secured by taking the gross weight of organisms; in other cases the dry weight is used as a criterion, a method which obviously may be used only in securing end or total results. A count of the number of individuals may afford a reliable basis for the estimation of the rate of growth and multiplication of unicellular organisms such as bacteria, in which the limits of enlargement of the individual are quickly reached. Much of the value of the results presented in the present volume is to be attributed to methods by which the varying dimensions of organs and of individual plants were followed not only through the entire period of development, but alterations accompanying maturity were measured with some precision. The information thus secured made it possible to interpret the effects of the ever-changing daily complex of environic factors and to evaluate to some extent the effects of previous experience upon the behavior of a growing organ at any stage of its development.

Thus, for example, the action of a cell-mass at any given temperature is influenced not only by the degree of the temperature and other environic conditions at that time, but also by the previous experience with these factors, particularly temperature. This "memory" of antecedent impressions is not psychological in any sense, but rests upon definite properties of colloids which are known or are measurable.

The diversity of constitution and consistency and variation in colloidal condition of living matter is so great as to evade exact or detailed description. But the general composition of protoplasm, the character of its activities, the mode or manner of changes in its colloidal states, and a measure of the factors affecting its activities may be comprehended without leaning upon vitalistic conceptions or resorting to mysticism in any form. The fundamental and ultimate structure or architecture of protoplasm is a result of the force of surface tension and is a gel in which the solid material occurs in two main states or phases

with water. In the more liquid phase the molecules of the substance are associated with such a large proportion of water as to be in a suspended condition, while in the more solid phase the proportion of water is much less. This phase has a distinct architecture which has been likened to that of a mesh, felt, foam, or honeycomb, in which the denser phase forms the framework and the fluid fills the interstices. Under certain conditions the phases may be reversed, and the solid particles be rounded into globules entirely surrounded by the fluid. These structures are far too minute to be visible under the microscope, as the particles which are dispersed in the liquid or are aggregated in the denser structure may each consist of a few molecules only. In addition to the material in the actual sponge of protoplasm, some of the same or other substances may be present in dispersions or solutions in cavities and spaces in the cell, which result from morphological or mechanical action of the protoplast (see p. 21).

The aggregation of molecules of a substance in a colloidal condition such as that noted above is a more complex matter than that of the solution of a crystalloidal compound, as, in addition to the forces of chemical combination, surface tension results in adsorption or union of substances in indefinite proportions.

Four main groups of substances make up the protoplasmic engine—carbohydrates, proteins and their derivatives, the lipins, and the salts. Perhaps all carbohydrates may exist in a colloidal condition, but the group polysaccharids, including the pentosans, are the most important in the architecture of the protoplasmic mesh, as these substances with proteinaceous compounds appear to determine the water-relations of living matter, and to contribute to the design of a machine in which metabolism takes place. The proteinaceous substances may in plant protoplasm form a widely varying proportion, generally very low, but sometimes ranging as high as 90 per cent of the entire dry weight of the protoplasm, with very important consequences as to imbibition. The enzymes are included with these substances, and as the metabolism, including respiration of plants, is predominantly a complex of transformations in carbohydrates, the possibilities of variation in this feature are very great. The nature of the pentose derivatives present in the protoplasm may also be a feature of considerable importance in metabolism and water-relations, as suggested by the differential behavior of various gums and mucilages when compared with that of agar. The colloidal carbohydrates, or those which enter into the make-up or design of the living machine and the proteinaceous substances, are theoretically mutually nondiffusible, so that the gelation or solidification of a 10 per cent solution of agar and gelatine or starch and gelatine according to Beijerinck<sup>1</sup> would result in a mechanical

<sup>1</sup> Beijerinck, M. W. Ueber Emulsoidenbildung wässriger Lösungen gewisser gelatinierender Kolloide. *Zeitsch. f. Kolloid-Chem.*, 7:16. 1910.

mixture of the two substances in which the two would exist separately in their characteristic emulsion. The amino-acids, on the other hand, diffuse readily into the colloids, and these may be visualized as being aggregated with the carbohydrate colloid, in both phases, and, as may be seen by reference to Chapter II, they set up water-relations different in some features from those determined by the hydrogen and hydroxyl ions.

The place of the lipins in the hydration mechanism can not at present be made the subject of profitable conjecture. While lecithin, for example, is known to adsorb water, its part in the living matter of the plant must be all but negligible, as it by no means bulks as large here as in the animal.

The general effect of the salts is to lessen the imbibition capacity of agar-protein mixtures when in simple solutions from a concentration of 2 N to 0.00005 N. Set in action with acids or in antagonistic relations, other effects are produced in sections of living plants. Although one of the subjects receiving the most attention in colloidal physics, and although extensive experiments with tissues and cell-masses of plants and animals dealing with the matter have been made, it is not yet definitely determined whether or not the action of a salt upon a biocolloid may be expressed by the algebraic summation of its acid and base as originally proposed by Pauli for gelatine, or whether the effect is due partly to other factors.

The extent to which protoplasm may be made up of dense particles of substances of a single category, such as protein or globulin granules, starch grains, or of minute masses of more highly hydrated strands or globules of albumin or of carbohydrates, or lipins, or of combinations such as those of lipin and protein in the mitochondria, can not be visualized. Neither is it possible to say whether the carbohydrate and protein molecules are equally aggregated in both the continuous or external phase and the discontinuous or internal phase of the gel, or whether one predominates in each phase according to the proportions in which they are combined. In any case phase reversals are possible. The imbibitional reactions of the living matter of plants are seen, however, to be parallel to those of a salted carbohydrate-protein gel combined in a high state of dispersion and questions as to systemic arrangement must be left in abeyance for the present. So far as known, it is the actual composition and relative proportions of the substances of the main organic groups and the amount, the stage, and sequence of incorporation of the infiltrated salts that constitute variables of the first order of importance in the determination of the behavior of the mass.

The chief distinction between the protoplasm of plants and that of animals may be taken to lie within the play of these major features. Living matter in animals includes lipins and consists predominantly of nitrogenous material, which displays maximum hydration capacity in

a hydrogen-ion concentration above the iso-electric point, or, as commonly expressed, when in a state of acidosis, in consequence of which many sweeping premature generalizations have been made as to the relations of electrolytes to protoplasm. Plant protoplasm, in so far as the higher forms are concerned, is poor in lipins, is usually characterized by a major proportion of carbohydrates, although in such simple forms as the bacteria the protein content may be very high. The water-relations of a cell-mass in plants will naturally be determined by its protein-carbohydrate ratio, with the implied corollary that a varying hydration capacity is displayed which may reach its maximum in a condition of acidosis in forms rich in nitrogen, and in a neutralized, relatively salt-free condition in those in which the proportion of colloidal carbohydrate is relatively great.

Cytological science recognizes that homogeneous states of the colloids do not prevail throughout the cell and a vast literature has grown up concerning the masses of unlike composition, structure, and form, some of morphological value, which make up the cell-body. Attention has naturally been concentrated on the more readily visible, durable, and measurable bodies, some of which are indubitably the scene of performances of the first rank, and form the chief mechanism in genetics.

It is not to be forgotten, however, that the diverse mixtures of gels and sols constituting the greater part of the protoplasmic mass, the structure of which may not be resolved by direct microscopical methods, is the ultimate colloidal machine in which the organs of the cell are built up, torn down, and metamorphosed. The study of some of the solid bodies in the protoplasm may yield the same comprehension of the play of chemical energy and surface tension of living matter as might be gained of the cyclonic forces of a storm by a measurement and dissection of hailstones. The greatest possibilities in cell mechanics are those which lie in the changes in viscosity, volume, and water-relations of cell-organs as determined by the composition and arrangement of the colloidal emulsion or mesh and the nature of the metabolism which goes on in its sols and gels.

It is also to be emphasized that it is not only untrue but unprofitable to assume that the living matter of plants and animals have the same general chemical properties. The difference in the occurrence and rôles of lipin in the two groups is fundamental, and, in addition to the water-relations, the metabolisms of the two present differences not attributable simply to the carbohydrate-protein ratio in their composition. Thus the living matter of plants includes within its metabolic cycles such features as the synthesis of the carbohydrates and of the amino-acids, the last-named capacity being exhibited only to a very limited extent by animals, which, in the main, are characterized by a metabolism of sugars notably different from that of the plant.

Available experiences with protoplasm lead to the conclusion that it may be considered as a system of gels and sols in which the component material is found in different conditions with respect to the proportion of water combined or associated with it (see Chapter II). The more fluid parts of the cell owe their liquidity to the fact that in such material water containing a small proportion of the colloidal material forms a medium or continuous element in which aggregations of molecules or submicrons combined with a smaller proportion of water are dispersed and may move about more or less freely. This condition may be predicated of the contents of the vacuolar cavities and of the regions in the cell which appear clear or vacant in living material or in cytological preparations. The denser parts of the protoplast would be composed of a much larger proportion of aggregated matter separated by much thinner or more attenuated layers of the more fluid phase.

Some writers assume that the submicrons of colloidal material aggregate to form a continuous framework or structure which has been likened to a fine sponge, network of fibers, or honeycomb. The more liquid colloid fills the cavities or interstices of the framework. This condition may not be so completely the reverse of the preceding as to bring the more fluid colloid into complete discontinuity. It may be safely assumed, in fact, that almost any mass of active protoplasm includes both conditions, and in a very fluid portion of the living matter small fragments of gel may be carried, while even in the denser newly separated embryonic cell-regions minute cavities may be formed by syneresis in which the colloid is in its extreme disperse condition. Such syneretic cavities may well be the beginning of the vacuoles, in contradistinction to the view which assigns a definite morphological entity to these features.

The formation of these syneretic cavities, the size of the molecular aggregates, and many other features of a colloidal mass are affected by the dilution or dispersion of the original material, the rate of dehydration and gelation, and even such fundamental characters as the relations of the two phases may be affected by the origin and rate of deposition of the material. In addition to these very fertile sources of variations in living matter, the cell at most times carries inclusions, such as starch grains, crystals, and protein granules which are comparatively inert, partly by reason of their small surfaces, and may not exercise much influence upon the surrounding gel. Oxidation, proteolysis, hydrolysis, or solution of these bodies may set free or split the compounds included, and these, quickly diffusing through the colloidal mass, may play an important part in the morphological crises of the cell.

Many mistaken attempts have been made to compare the growth of organisms and the formation of crystals directly, and to establish their identity or continuity. The results of such efforts serve to bemuse the mystic, to divert the philosopher, and to furnish poetical conceptions



to writers who view matter and all material conceptions from a remote distance. Colloids, with their electrical charge, absorptive and adsorptive properties, and molecular arrangement, display a series of characters fundamental to organic growth, of which swelling as a result of hydration is one of the most noticeable, which do not extend to crystals.

Furthermore, the colloidal systems which are exemplified in living or organic material are rarely at rest in the sense of which this may be said of crystals. It is true, of course, that substances or formations may occur in nature or in the laboratory which are made up of both crystalline and colloidal material, and it is also true that some compounds may pass from one condition to the other, but the action by which a crystal is formed is not one coincident with colloidal reactions, nor does the perfect crystal behave like a mature cell, organ, or organism. In fact, the more perfect a crystalline structure may be, the farther does it depart from the state in which it might display activities or enlargements similar to those of growth of living matter.

The essential feature of an idealized growth is the accretion or addition of water and material to the mass of colloid constituting the cell. The actual mechanism of incorporation is not easily delineated. If protoplasm consisted of a system of colloidal structures such as those of the pentosans and the proteins interwoven but not diffusing into each other, the more solid material which lowers the surface tension to the greatest extent, having the least attraction for water-molecules, would tend to usurp the position of the surface layer. Furthermore the solid phase, whether it be in the form of globules or in the continuous element, would tend to increase and crowd together with a lessening of the more liquid phase. This would imply that when gelatine in small proportion is mixed with agar or starch in the larger proportion that the carbohydrate would form the colloidal framework or mesh as well as the external layer of the mass.<sup>1</sup>

The separate colloidal masses where they do exist have, of course definite boundary layers, as are formed wherever two colloidal phases meet. Protoplasm may not be regarded, however, as altogether a mechanical admixture of minute strands of material of different composition. Much of it, including the more fluid portions, must consist of molecules of carbohydrates, proteins, salts, and even lipins aggregated to form submicrons in the disperse phase or in the denser, more solid fibers, mesh, or honeycomb of the structure. The external layer formed might well be in a sense a mosaic, but it is to be noted that no actual proof of such a condition is at hand. Both absorption or imbibition and osmosis, including differentiated diffusions, would be affected by the composition and relations of the two phases of the colloids in this outer layer, and it seems highly probable that an adequate interpre-

<sup>1</sup>Free, E. E. A colloidal hypothesis of protoplasmic permeability. *The Plant World*, 21: 141. 1918.

tation of permeability will be obtained by a study of these features. Meanwhile no general agreement as to the nature of the "membrane" or its action is to be expected until many widely current assumptions are discarded. The external layer of a protoplasmic unit is in every case a product of the surface energy of the mass or systems of living material internal to it and of the medium, and has no other permanent or morphological value. Its constitution must necessarily vary widely, as does that of the living protoplasm.<sup>1</sup>

This aspect of the external layer is one which finds recognition among writers on biophysics in various ways. Mathews assumes conditions in the protoplasm which are not valid in plants when he says:

"Thus it is suggested that in the surface of contact of protoplasm with water, lipin substances will accumulate and thus make a kind of intermediate layer of a lower surface tension and of a fatty nature. But, inasmuch as the whole substratum of the cell is of a fatty or lipin nature, it is difficult to see how the surface tension of the junction of fat and water could be changed by the passage of more lipin into the film; and, as a matter of fact, there is no good evidence that there is such a layer about the protoplasm."<sup>2</sup>

McClendon recognizes a wider range of facts,<sup>3</sup> as follows:

"The composition of the plasma membrane remains a mystery. It seems logical to assume that its building stones are selected from the chief constituents of cells, proteins, fats, lecithin, cholesterolin, and carbohydrates. It is a very unstable structure, as will be shown later."

An admirable presentation of the matter is to be credited to D'Arcy W. Thompson, the keynote of which lies in the sentences:<sup>4</sup>

"The adsorbed material may range from the almost unrecognizable pellicle of a blood-corpuscle to the distinctly differentiated 'ectosarc' of a protozoan, and again to the development of a fully formed cell-wall, as in the cellulose partitions of a vegetable tissue. In such cases, the dissolved and adsorbable material has not only the property of lowering the surface tension, and hence of itself accumulating at the surface, but also has the property of increasing the viscosity and mechanical rigidity of the material in which it is dissolved or suspended, and so of constituting a visible and tangible 'membrane'."

In addition to the external layer of the highly hydrated protoplasm, this living material is usually separated from the surrounding medium by walls or coats of specialized character, variously formed, and which may be composed in part or altogether of material originating outside of the masses which they inclose, which may modify the diffusion of liquids into the colloidal mass in a very important manner.

If the swelling is one of simple hydration, the entrance of additional water would result solely in an increased dispersion of both phases of

<sup>1</sup> See Stiles and Jorgensen, Quantitative measurement of permeability. *Bot. Gazette*, 65: 526. 1918.

<sup>2</sup> Mathews, A. P. *Physiol. Chem.*; 2d ed., p. 211. 1916.

<sup>3</sup> McClendon, J. F. *The physical chemistry of vital phenomena*, p. 95. 1917. Princeton Univ. Press.

<sup>4</sup> Thompson, D'Arcy W. *Growth and form*, pp. 281 and 282. 1917. Cambridge.

the colloid. If dissolved salts are carried by the water, these substances might unite chemically with the material in the molecular aggregates in both the more liquid and the more solid phases of the colloid and cause changes in the water-relations of the mass, or the dissolved substances entering with the water might form adsorption compounds by the uniting in indefinite proportions with the colloidal material in which the water-relations might be changed in another way. Such changes would, of course, be followed by variations in volume. It is to be added that water itself may enter into both relations with the colloidal material and that the initial swelling of a dried colloid probably includes such a chemical combination of water with its molecular aggregates. The action of salts or of acids brought into the mass with water may be such as to carry the dispersion or solvation to the stage in which the mass assumes a liquid condition.<sup>1</sup>

In that type of growth in which carbohydrates or proteins are carried into the mass by water, it may be seen that the accumulation of the additional material in the more liquid phase would by the action of the forces of surface tension result in the aggregation of new masses of material. Such formation of additional elastic gel structure might occur theoretically throughout the entire mass of the cell, but in actuality would be modified and controlled at every point by the factors which affect hydration. Aggregation of material in synergetic cavities may be taken to present possibilities of the formation of specialized protoplasmic masses or cell-organs or of secretions. Writers with a keen historical sense may be disposed to see in the conceptions outlined above a modernized statement of the micellar hypothesis of growth of Naegeli, but no great interest may be attributed to any such forced parallelism.

The measurements described afford a reliable basis for the conclusion that the extent and character of the swelling of gels compounded of carbohydrates and proteins or protein derivatives depends in great degree upon the proportions of the main constituents, not only with respect to pure water, but in solutions of salts and electrolytes in general. The general effect of a salt on hydration depends upon its concentration and whether it is already present in the colloid in chemical union or in adsorption with the colloidal material, or whether it enters with the solution or water of hydration; also upon the character of the salts adsorbed. The extension of the observations upon which these conclusions rest to living cell-masses and to desiccated and dead material from plants demonstrates that colloids may be compounded which may simulate with fair parallelism cell-colloids with varying carbohydrate-protein ratio, salt-content, and acidity. In no feature is this more striking than in the temperature relations. The rate and amount of swelling of plants, and of colloidal mixtures which simulate

---

<sup>1</sup>Ostwald and Fischer. *Theoretical and applied colloid chemistry*, p. 101. 1917.

them, in water or in some solutions may increase from temperatures near the freezing-point to 39° to 46° C. and then fall off above this region, or in acid solutions of a concentration normal to the plant both biocolloids and sections of living and dried plants may show decreased hydration as the temperature rises above 17° or 18° C.<sup>1</sup>

Nowhere is metabolism more active than in the embryonic growing cell. The dissociations which are usually included in the conception of respiration may be taken to concern molecules of material already present in the more liquid phase of the colloid or newly introduced. The splitting of the sugars results in the formation of acids as one stage of the process, and if the succeeding stages are impeded such material accumulates, acidosis results, with new temperature relations which may affect imbibition and the enlargement constituting growth in a profound manner. Other actions will depend upon the composition of the cell with respect to its carbohydrate and proteinaceous constituents. If it is high in albuminous material, its capacity for absorbing and swelling may be greatly increased, while on the other hand this effect will be greatly lessened if a large proportion of pentosans are present, especially in the presence of salts. No further recapitulation of detail is necessary to emphasize the fact that the products of the reactions within the cell may be responsible for many of its most marked changes in behavior. Such changes do not in any manner give support or approval to vitalistic theories as to the constitution or activities of living matter.

The other soluble carbohydrates, including the hexoses—sucrose, dextrose—do not occur in the cell in such concentration as to affect the enlargement of the protoplasmic mass directly, but in the vacuoles they may exert an osmotic effect additive to that of the amino-acids which may accumulate in these cavities. It is to the osmotic activity of these substances in the vacuoles that turgidity is due, and a by no means unimportant part in the maintenance of the rigidity of organs and other features is to be ascribed to these turgor stresses and tensions. That osmotic pressure may also play an important part in the enlargement of the plant cell may well be concluded from the fact that in the stage following the initial swelling of the embryonic cell a large share of the increase in volume is due to the increase of the vacuoles. The inadequacy of osmotic phenomena and of the conception of the semipermeable membrane to provide a mechanism for the translocation of complex material from cell to cell, and the incorporation of new material in a growing mass has long been recognized. It would be a mistake to conclude that the vacuole is simply a sac charged with electrolytes, as these cavities invariably hold proteins and carbohydrates in a colloidal condition in which the degree of dispersion may

<sup>1</sup> MacDougal, D. T. The relation of growth and swelling of plants and of biocolloids to temperature. *Proc. Soc. for Exper. Biol. and Med.*, 15, No. 3, p. 48. 1917.

vary widely, but still absorb water. A correct delineation of the manner in which osmosis and imbibition interlock in growth is one of the tasks demanding the immediate attention of the physiologist.

It has been assumed in the present work that when the chief constituents of protoplasm are brought together in a colloidal condition, approximating that of living matter, the behavior of this material would furnish data fundamental to the physics of growth. The justification for this assumption is to be found in the following pages, in which are described the reactions of biocolloids, of dead sections, and of organs of living plants in hydration and growth as affected by solutions, culture media, the products of metabolism, and environmental agencies, especially temperature.

## II. FUNDAMENTAL FEATURES OF PHYTOCOLLOIDS.

It became evident in the earlier stages of the studies described in the present work that the swelling of gelatine does not afford a parallelism to the action of vegetative cell-masses of the higher plants, and that only in certain reproductive elements or in some of the lower forms is the proportion of nitrogenous material sufficiently great to give reactions similar to those of gelatine. Experimental demonstrations of the general character of the cell colloids was first made with sections of joints of *Opuntia*. The results of an extended series of analyses of these plants made by Dr. H. A. Spoehr covering all of the seasonal changes were available, and from his results it can be seen that their general composition is about as shown in table 1.<sup>1</sup>

TABLE 1.

Constituents.	Young joints.	Old joints.
	p. ct.	p. ct.
Water.....	95	75
Crude protein.....	0.5	1.0
Carbohydrates hydrolyzable with 1 per cent HCl.....	1.0	10.0
Cellulose.....	1.0	3.0
Crude fat.....	0.25	0.5
Ash.....	1.0	3.5

The hydration of an organ or cell-mass with a composition similar to that shown in table 1 would of course be determined by the hydrolyzable carbohydrates and proteins and affected by the salts.

The first experiments were directed to ascertaining some of the reactions of the carbohydrates which are known chiefly or entirely in the colloidal form and which might be a constituent of the plasmatic gels. The most readily available representative of these substances was agar. Strands of the material were liquefied in water at 60° or 70° C., poured into shallow molds with the area of a postal card, and allowed to desiccate to plates from which pieces 3 by 5 mm. were cut. Swelling was measured by the auxograph, using an improved form, the essential part of which consists of a compound lever, the members of which are pivoted in adjustable bearings in a rigid brass frame.<sup>2</sup> The bearing lever has a forked free end suitable for the attachment of a counterpoise and of a vertical swinging arm of twisted brass wire. The free portion of this vertical lever is sheathed with a section of

<sup>1</sup> MacDougal and Spoehr. Growth and imbibition. Proc. Amer. Phil. Soc., 56 : 335. 1917. Philadelphia.

<sup>2</sup> *Ibid.*, 327.

glass tubing with thin walls, drawn to a point and sealed in a flame. The pointed glass tip fits into a hole in the center of a thin glass plate resting on the sections to be swelled. The attachment of the swinging lever to the free end of the bearing lever may be adjusted to give an amplification of the swelling, which is recorded by the pen tracing an inked line on a sheet of paper 8 cm. wide ruled to millimeters. The paper is coiled inside a brass cylinder and issues through a slit passing to the drum of a clock of the same pattern as used on standard thermographs in such manner as to present a uniform plane surface to the action of the pen in all parts of its arc. The tautness of the paper may be varied by altering the position of the slit in the brass cylinder and clocks may be employed which give the paper a motion of 28 cm. in 24 or in 168 hours. The two levers are connected with a short length of jeweler's chain to minimize friction, and the base of the frame carrying the levers is seated on the top of a rack-and-pinion column with a vertical motion of 12 cm. and is capable of being fastened rigidly at any height within its range of 10 to 12 cm. (fig. 1).

The dishes finally selected for containing the sections to be immersed in solutions were of the Stender type, 5 cm. in diameter and 24 mm. deep. It was found advisable to have the surface of the bottom inside the dish ground plane in order to avoid slipping and movement of the swollen sections and of the delicate jellies formed by the biocolloids when in states of extreme hydration. For similar reasons it was necessary to place the entire preparation on a concrete pier, or still better upon a slab of marble, granite, or concrete, "floated" in a large box of sandy loam which had a direct bearing on the ground. The dishes containing the sections were seated on various supports, the best form being that of an iron or concrete cylinder about 12 cm. in height and 10 cm. in diameter. Three soft-metal studs were let into the basal end of this cylinder to give it a three-point bearing on the marble slab. With preparations made in this manner and with the counterpoise arranged to give the least weight upon the swelling objects compatible with a steady following movement of the pen, it was possible to obtain valuable records of the velocity and course of swelling of sections of plants and of various colloidal substances. It was soon learned that more reliable results might be obtained with thin sections, in which the coefficient of expansion would be high and complete hydration would be attained quickly and with less dispersion of the colloid in the liquid.

No records of temperature in the earlier tests were kept, but any set of swellings, generally of three or four different solutions, were carried on simultaneously and under the same conditions. It is to be understood, therefore, that in tabulated data, as table 2, the relative swelling of sections of one sample in the different solutions at the same time only may be compared. The experiments had not been carried very

far before it became apparent that the temperature of the solution in which the swellings were made was an indispensable feature of the control, and as but few contemporary workers have recorded this condition, it is not possible to cite their results with profit.<sup>1</sup> Some interesting results are illustrated by the figures obtained without temperature control, which derive their value from the fact that all of those in

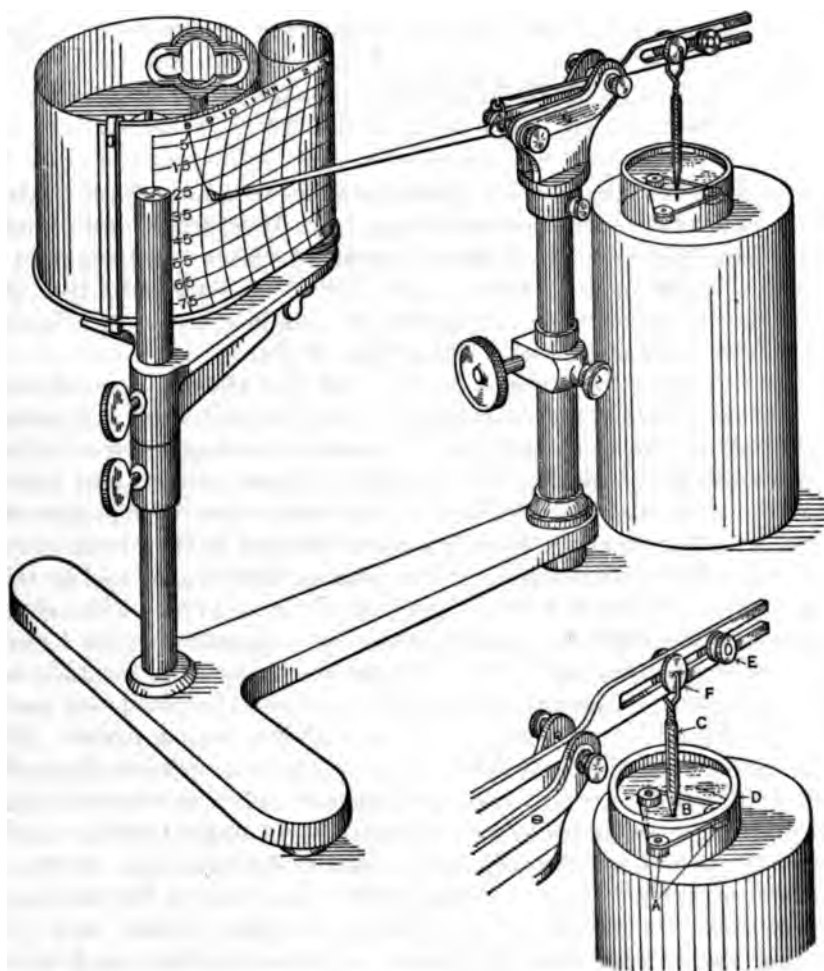

FIG. 1.—Auxograph arranged for recording changes in thickness of trio of sections of *Opuntia* and of biocolloids. The vertical arm, which is set in position on horizontal arm to give an amplification of 20, rests on a triangle of glass laid on top of the sections. The dish containing the sections rests on an iron cylinder to secure stability and a weight is placed on the T base of the instrument. The record sheet is ruled to millimeters (not shown) with heavier horizontal lines 1 cm. apart. The heavy curved lines represent hour intervals. The space is ruled to 15-minute intervals (not shown). Height of clock and lever supports adjustable.

<sup>1</sup> MacDougal, D. T. The relation of growth and swelling of plants and biocolloids to temperature. Proc. Soc. Exper. Biol. and Med., 15 : 48. 1917.



any given line have been obtained under identical conditions. One of these comparative series made in 1916 may be cited as an example of the relative behavior of agar and gelatine to water, acids, and alkalies.

TABLE 2<sup>1</sup>.

	Swelling of agar.	Swelling of gelatine.
	<i>p. ct.</i>	<i>p. ct.</i>
Sodium hydroxid (hundredth molar)...	124	250
Hydrochloric acid (hundredth molar)...	113	382
Water.....	197	83

The next departure in the experimentation was to make a mixture of these two substances as representing the carbohydrates and proteins of the plant, and this was done in a series of plates in which the two elements entered in proportions from 1 or 2 to 9 parts in 10. The diverse results which were obtained gave ample promise of affording many useful comparisons with the action of plants.

It was, of course, not taken for granted that the amino-acids used duplicate those which are found in the plant or that such compounds afforded all of the more important factors affecting water-relations. The next step in the making of a colloidal mixture which might imitate the action of the plant in relation to water was to use various albuminous compounds to furnish the nitrogenous element in the biocolloids.

According to Beijerinck and others, combination of agar and gelatine or gelatine and starch in a 10 per cent solution would result in a simple admixture of the colloidal masses of the two substances in the form of minute masses or strands.<sup>2</sup> Such mixtures would be more intimate and present greater surfaces than those made up from the powdered material brought together with little water and at low temperatures. Progressively finer subdivision of the materials and more perfect dispersion would finally reach a point near the limits of gelation where the sub-microns of agar and starch, for example, might come together in the walls or fibers and in the more liquid part of the two-phase system of colloids, and the substances in the parts remaining to fill cavities or vacuoles might be in various groupings, according to one view. On the other hand, very weighty theoretical considerations lead to the conclusion that the relations of the carbohydrate-protein substances in such a system would be determined quantitatively. Thus a mixture of 8 or 9 parts of agar and 1 or 2 parts of gelatine or albumin at a high degree of dispersion would be followed by a gelation in which the predominating substance, agar, would form the external or continuous

<sup>1</sup> MacDougal, D. T. Imbibitional swelling of plants and colloidal mixtures. *Science*, 44 : 502. 1916.

<sup>2</sup> Beijerinck, M. W. Ueber Emulsoidenbildung bei der Vermischung wasseriger Lösungen gewisser gelatinisierender Kolloide. *Zeitsch. f. Kolloid-Chem.*, 7 : 16. 1910.

phase, and the protein the internal discontinuous or globular phase. This conception is a very attractive one because of the possibilities implied. Included among these would be the play of osmotic forces in the inclosed and non-diffusible gelatine, which might be a contributory factor in the high swelling coefficients displayed by biocolloids.<sup>1</sup>

The sections and plates of agar and proteins, amino-acids, etc., used in the accompanying experiments probably included the materials in many possible arrangements, but as the method of preparation was uniform, the relative value of the results obtained from them remains unimpaired. This heterogeneity is a direct resultant of the varying history and unequal disposition of the material which enters into the colloidal mass, and would find direct parallel in living matter, which is practically never homogeneous as to composition or uniform as to architecture throughout any measurable mass, and hence its morphological units are not isotropic as to action when measured with commensurate accuracy.

The experimenter dealing with the hydration of these elastic gels does not proceed far before he becomes aware that the method of compounding, melting, drying, temperature, and other features of the experience of the biocolloids influence the behavior of the thin plates which may be made from them. It will be important, therefore, to describe the preparation of the sections which were used in these and other tests.

The agar and the proteinaceous material should all be from one source and if possible from a single lot in any comprehensive series of tests where close comparisons are desirable, as it can by no means be assumed the composition of separate lots will be identical as to salt or nitrogen content. The variations in gelatine are not so easily apprehended. Both agar and gelatine, or other proteinaceous compound used, should be first soaked in distilled water at some temperature between 15° and 20° C. for a period of a half hour. The agar is now heated with an amount of distilled water over a water-bath that will bring it to a 2.5 per cent solution or suspension. The suspension of the agar may be accomplished more quickly by the use of an autoclave. When this is completed, and it is difficult to bring the last particles into liquid form, it should be filtered hot into a flask to obtain a clear solution. If the biocolloid is to be made by the addition of an amino-acid, any one of these substances may be added at temperatures between 50° and 80° C., but when albumins are used the agar solution must be cooled in a warm water-bath until it comes down to a temperature below the coagulation-point of the latter substances. This will be found somewhere below 40° C., and the protein solution should be poured in with sufficient stirring to procure good admixture, or the same end reached by a vigorous shaking.

---

<sup>1</sup> See discussion in Robertson, T. B., *The physical chemistry of proteins*, pp. 294-350. New York and London. 1918.

The most useful amount of material for making dried plates of a thickness of 0.3 mm. or less is that which includes 10 grams of dry material made up to a 2 per cent liquid or solution. This amount will form two plates about 8 by 15 cm. which will come down to the desired thickness when dried at 15° to 20° C. Two methods of casting such dried plates may be used, according to the composition of the colloid that is being manipulated. Gelatine, or plant mucilages, or mixtures in which these substances compose half or more of the whole, must be poured directly on glass plates or on sheets of gold or platinum foil.

A sheet of plate-glass with a good surface is set in a level position after the surface has been well cleaned and polished. A cell about 8 mm. in depth and 10 by 15 cm. is now made on it by glass strips fitted together so closely that when the warm material is poured onto the glass it will not leak out at joints or corners. After the mixture has cooled sufficiently for the gel to set, the plate is placed in the desiccator and drying should be carried on at such rate that no further loss of weight occurs after about 40 hours. The dried plate is now worked free from the glass at one margin by an instrument with a chisel edge and then stripped free, after which it should be placed in a closed glass dish to keep it free from dust and undue desiccation, which would produce buckling or warping.

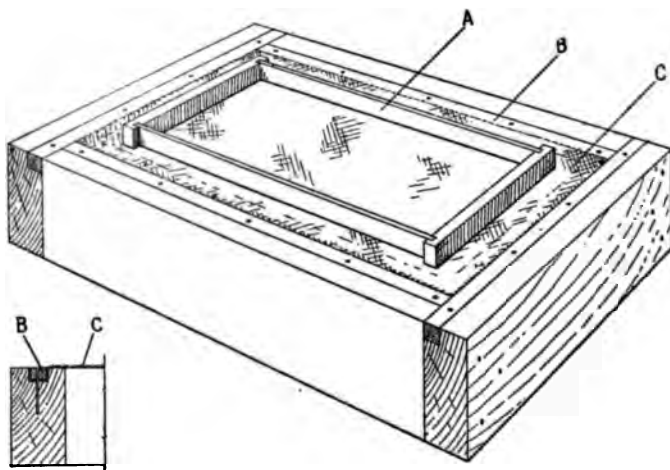

FIG. 2.  
Drying frame. A sheet of wire gauze of 1 mm. mesh stretched on a heavy wooden frame, being fastened securely in place by a tightly fitting strip of wood which carries the margin of the netting down into a groove in the frame, as shown in the smaller detail drawing. A, molding form of brass bars; B, margin of wire netting and clip fastening it in place; C, wire netting as it clears frame. The wire netting and brass bars are coated with fine shellac.

Many plates are ruined in the method described, and when possible the following devices will be found useful: A sheet of rustless wire screen with a mesh less than 2 mm. is stretched on a heavy wooden frame (see fig. 2), so as to offer a good plane surface. A mold of four brass bars is laid on the surface and a sheet of hard filter-paper, such as Whatman No. 40, is fitted into this cell. The frame is placed in a level position and the mixture poured into the shallow cell to a depth of about 8 mm. (fig. 3). After it has cooled and set, the brass members

of the shallow cell are removed and the filter-paper is peeled from the margins and the free flaps are fastened by paste to the edges and surfaces of the wooden frame so as to be perfectly taut and so firmly that when the colloid dries it may not shrink in width or length. Additional care should be taken to see that the material does not tear loose from the paper at this time, and if it does it should be secured by using some fresh material as a paste to fix it to the paper. The margin dries most rapidly, and if securely attached to the paper holds the plate in place throughout (see fig. 4).

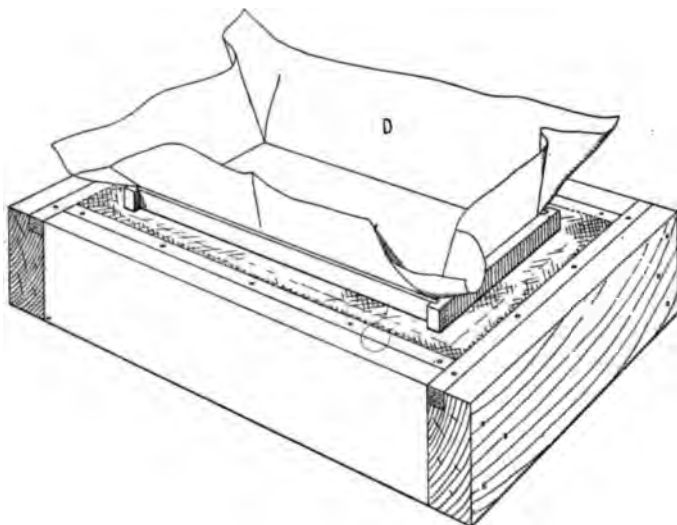

FIG. 3.  
Drying-frame with sheet of hard filter-paper fitted in place ready to receive liquid colloidal mixture which is to be poured on the paper to a depth of about 8 to 10 mm.

The drying-frame is now placed on a rack in a desiccator which consists of an inclosed chamber in which is placed an electrically driven fan and a large, shallow pan of water. The best results are secured by a rate of drying which results from having air with high humidity driven over the plates constantly without dehydrating the surface layers too rapidly (fig. 5). Drying will occupy about 40 hours, during part of which time it may be advisable to stop the fan. As soon as the sheet appears to be dried to a flexible, leathery consistency the paper may be freed from the frame and then stripped from the plate of material, which should remain plane, with but little curling or buckling. The rough and uneven margin should be cut away with scissors, the data as to composition, etc., written on one end with common ink, and then placed in a closed dish for preservation until used.

The precautions described are necessary in any effort toward accuracy in the measurement of the swelling of a colloid, as the increase will, among other factors in its experience, reflect most strongly the method in which it was laid down, deposited, or dehydrated. A dried section of a colloid of the kind used in these experiments tends to return to the dimensions which it had when the gel set or cooled. Standardization

of material for measurement of swelling under the influence of various reagents or agencies would therefore require that the shrinkage of the material as it dries should be controlled. This may be done in many cases in the manner described. Thus in the case of biocolloids con-

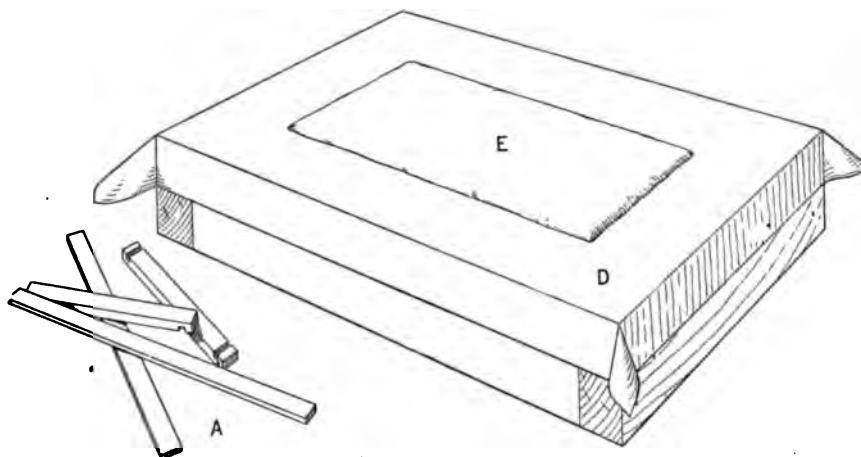

FIG. 4.—Drying-frame with plate of colloid, ready to be put into the desiccator. The molding-bars *A* have been removed and the free portions of the filter-paper have been carried down over the side of the frame and fastened securely in place with paste.

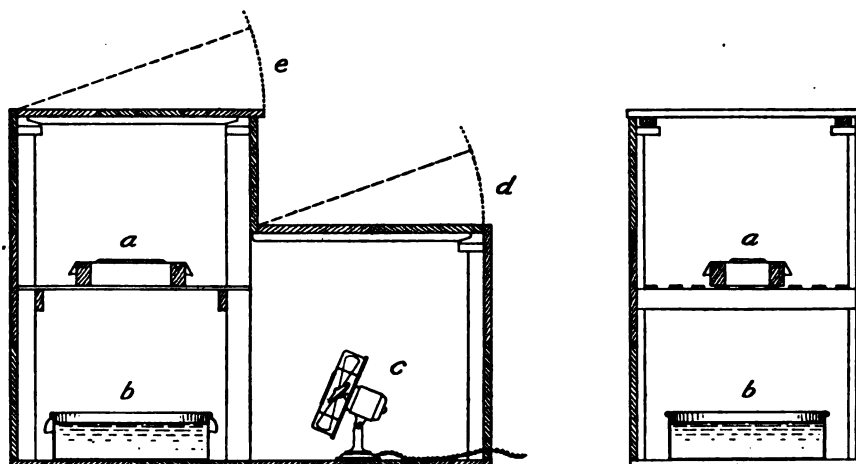

FIG. 5.—Sectional views of desiccator for drying plates of colloids. *a*, frame with drying-plate lying on a sheet of stretched filter-paper, which in turn is placed on a shelf of slats; *b*, metal pan containing water to maintain relatively high humidity; *c*, electric fan arranged to keep current of air moving over the surface of the water, the plate of colloid, and in circulation in the chamber; *d* and *e*, hinged lids which may be raised to control ventilation and the relative humidity of the chamber. A wooden chamber about a meter in height, over a meter in length, and 80 cm. in width.

sisting of 9 parts agar and 1 part bean albumen a plate cast in this manner came down so perfectly that a strip 30 mm. in length placed in distilled water swelled over 2,000 per cent in thickness, but did not increase any measurable fraction of a millimeter in length. A strip

cut from the extreme margin of the plate would doubtless have shown some elongation.

The marginal strip of a plate consisting of 6 parts agar, 3 parts gum arabic, and 1 part gelatine which had a length of 15 cm. increased to 15.5 cm. in 45 hours. To be compared with this elongation of 3 per cent is that of the increase of a pile of sections 2 cm. in height cut from the same plate, which rose to 15 cm. in 24 hours, showing an increase of 750 per cent. The proportion would doubtless have been still greater had the swelling of one section been measured alone, as trios of sections cut from the middle of the plate showed swellings of 1,141 per cent at 14° to 17° C.

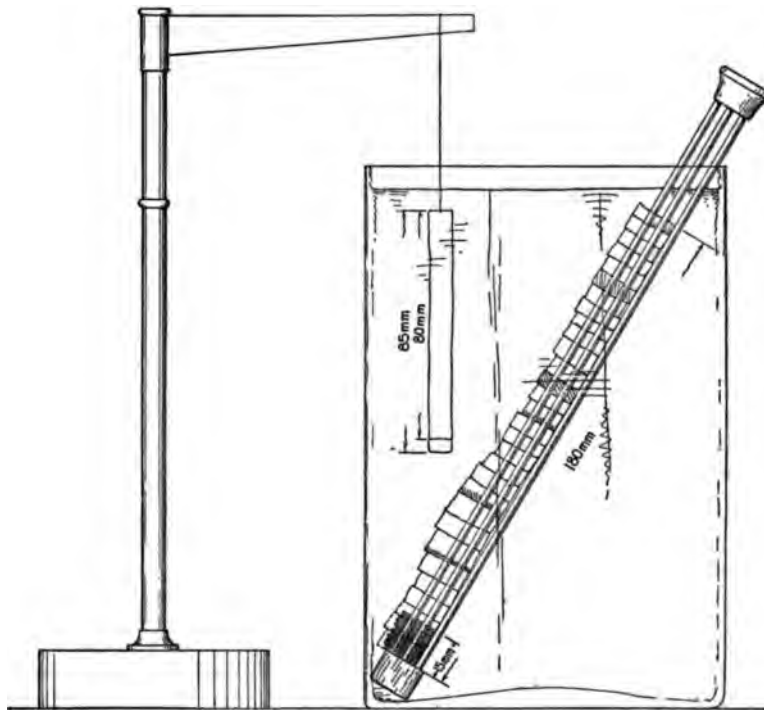

FIG. 6.—Demonstration of the swelling of sections of plates of agar 4 parts, opuntia mucilage 4 parts, gelatin 1 part, bean protein 1 part, in thickness with but little increase in length, due to the manner in which the moist colloid was held while drying.

Another test of the same kind is illustrated by figure 6. Sections of a plate consisting of 4 parts agar, 4 parts opuntia mucilage, 1 part gelatine, and 1 part bean protein were placed in a frame of glass rods and immersed in a vessel of distilled water, swelling from a total thickness of 15 mm. to a total of 180 mm., while a strip cut from this plate which had an initial length of 8 cm. had elongated to 8.5 cm. The increase in thickness was 1,200 per cent, while that in length was but 6 per cent.

Plates of gelatine invariably showed a greater increase in areal dimensions than that is such as those mentioned above, and

no plate was made in which this was entirely eliminated. Thus a plate which would yield increases in thickness of 6 to 800 per cent in trios of sections in distilled water reached a length as much as 50 per cent greater than the original under the same conditions.<sup>1</sup>

A unilateral action such as that described is one which appears to rest upon the supposed honeycomb structure of the colloid. Dehydration would lessen the volume of the mass, and as the sheets or strands of denser material are held in a plane parallel to the surface, the spaces containing the more discontinuous, more liquid element would be deformed and their vertical diameter decreased. Accession of liquid or of water would be followed by the partial resumption of the original form and dimensions. Experience in dealing with a large number of plates leaves the impression that the swelling does not bring the sections back to the thickness of the cooled gel as it was originally in the mold.

The fact that colloids such as those present in living matter may retain a shearing strain was recognized by Butschli and was the subject of some experimentation by Hardy<sup>2</sup> in a study of coagulation phenomena, who concludes that "shearing a colloidal mass, fluid or solid, actually does produce heterogeneity or, simply, structure, which is fixed by the process of coagulation." Such sheared masses of colloid are doubly refractive. Klocke demonstrated the acquisition of such double refraction by sheets of gelatine which were dried on frames covered with tin-foil. It is to be noted that the plates of gelatine which were dried without superficial shrinkage in my own experiments when hydrated showed some extension, while those of the agar-protein mixture did not. The hydration in both cases presumably removed the strain as the structure produced by the stress disappeared. Great cytological interest attaches to the simple experiment by Hardy, in which a small quantity of a colloidal solution is drawn along a glass slide by the point of a needle, after which it is "fixed" by the methods of the cytologist, with the result that the mass appears to consist of a number of fibrillæ "\* \* \*" so striking that they look as if one might isolate them by teasing."

Much interest also attaches to some recent work of Miss C. L. Carey of Barnard College upon the structure of agar films. 2.5 per cent gels of this substance were prepared by a method similar to that described on page 16 for preventing superficial shrinkage. When such plates were dried at 45° to 70° C. and again placed in water the rehydrated plates yielded drops of water so readily that an examination of thin sections under the microscope was made, revealing cavities

<sup>1</sup>For the original notice of increase in thickness and not in length, see MacDougal and Spoehr, *Growth and Imbibition*, Proc. Am. Phil. Soc., 56 : 343, 344. 1917. Philadelphia.

<sup>2</sup>Hardy, W. B. On the structure of cell protoplasm. *Journal of Physiol.*, 24 : 158. 1899. See especially pp. 187-190. London.

with their long axes parallel to the surface, as shown in figure 7, which was furnished by Miss Carey in response to the request of the author.

The extraction and preparation of a number of substances, including protein from oats, albumin and globulin from beans, the total protein of beans, asparagin, aspartic acid, etc., was undertaken by Dr.

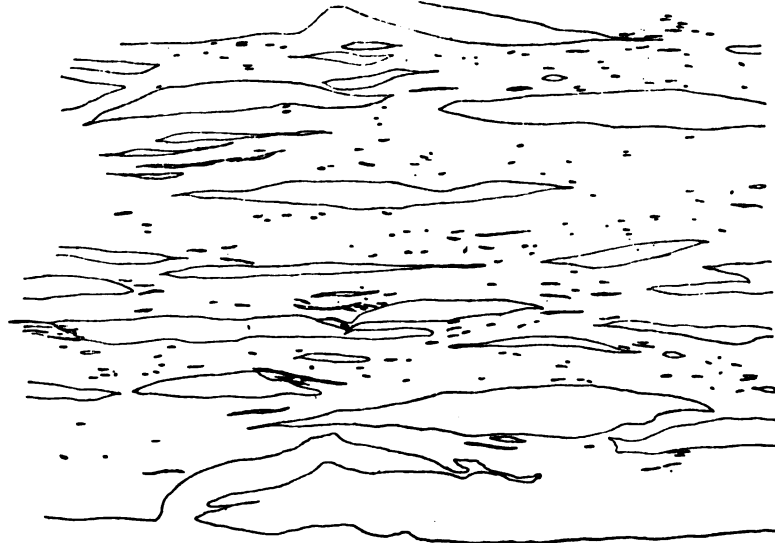

FIG. 7.—Longitudinal section of an agar plate dried at 70° C. without superficial shrinkage, with development of elongated spaces or cavities which are found when the film is hydrated. Drawn with camera lucida by Miss C. L. Carey.  $\times 78.5$  diam.

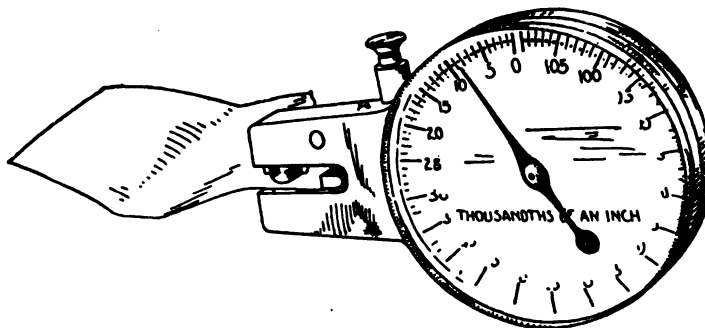

FIG. 8.—Scale designed for measuring thickness of paper and suitable for determining thickness of sections of plates of biocolloids. Sheets of a thickness of 0.001 to 0.11 inch (= 2.8 mm.) may be measured (see fig. 23 for calipers used in measuring larger objects).

Isaac Harris, of Squibb & Sons' laboratories, New Brunswick, New Jersey, while Mr. E. R. Long furnished preparations of such substances as zein, which made it possible to make up plates of biocolloids entirely from products of plants.

The swelling of mixtures of agar and of the protein extract of bean in plates 0.3 to 0.4 mm. in thickness were as shown in table 3.



The greatest capacities for hydration encountered were those in which plant proteins, such as those of oats, were added to agar in the proportion of about 1 in 10, a ratio which finds its equivalent in the constitution of many of the higher plants. The maxima exhibited by such mixtures are not duplicated by the plant, in which the presence of salts in the colloids and the morphological structure operate to limit the amplitude of the swelling.

TABLE 3.

	Dist. water.	Hydrochloric acid, 0.01 M.	Sodium hydrox., 0.01 M.
	<i>p. ct.</i>	<i>p. ct.</i>	<i>p. ct.</i>
Gelatine 90, protein 10 ( <i>Phaseolus</i> ) . . . . .	585 486 386	1,401 1,200 .....	942 704 800
Averages . . . . .	485	1,300	817
Gelatine 75, protein 25 ( <i>Phaseolus</i> ) . . . . .	696 500	818 1,060	621 848
Averages . . . . .	598	939	734
Agar 90, protein 10 ( <i>Phaseolus</i> ) . . . . .	800 800	50 75	150 150
Averages . . . . .	800	62	150
Agar 99, protein 1 ( <i>Phaseolus</i> ) . . . . .	1,080 800	300 360	220 240
Averages . . . . .	940	330	230

The method of admixture of the carbohydrate-protein-saline constituents of the biocolloids consisted mainly in the use of temperatures which would bring all of the substances into a liquid condition in which they might be as intimately united as possible, and the plates formed appeared translucent but uniform throughout, although it is not to be assumed that the components in this case or in any preparation, or in protoplasm, are mutually interdiffused. It seemed desirable to attempt to make mixtures in which the carbohydrate-protein elements would be less intimately united, and to that end some simple experiments with powdered agar and powdered gelatine were carried out.

Powdered gelatine and agar which would pass the millimeter mesh of a screen were used to ascertain what degree of expansion would be registered on the auxograph when these were simply placed in a layer in the dish and subjected to the action of solutions. Whatever the arrangement of the material in these particles, their separate action in swelling and in dispersion or solution would be free from the action resulting from structures such as those presented by plates held rigidly

while being dried. When a layer of powdered gelatine was placed in the bottom of a Stender dish to a depth of 1.5 mm. and covered with a perforated glass triangular plate which would go into the dish readily, a swelling of 270 per cent in water at 18° C. was registered by the auxograph. Furthermore, this increase was not the rapid swelling of a mass with subsequent relaxation, but lasted over 5 days; the greater part of the swelling occurred during the first half hour, then continued at a decreasing rate for the period mentioned.

A similar experiment was made with powdered agar, the particles of which were probably of a much smaller average size. The swelling was of the same kind, but was complete in 4 days, although reaching the higher total of 317 per cent. This higher hydration capacity is characteristic of agar as compared with gelatine.

It is of course to be expected that when two colloidal substances in a two-phase system are combined and the resulting material is subjected to agencies that will coagulate or neutralize one of them, the section would then show the relations of the one still in the colloidal state. This was demonstrated with some completeness by a mixture of agar and milk albumin.

Preparations in which 1 part albumin from milk was stirred into 9 parts melted agar at 40° C. and under, thus remaining active and suspended, showed swellings in the form of dried plates 0.1 to 0.15 mm. in thickness at 16° C., as shown in table 4.

TABLE 4.

	<i>p. ct.</i>
Water.....	1,792
Citric acid, 0.01 N.....	333
Sodium hydroxid, 0.01 M.....	386

The high swelling in water, the increased imbibition in acid, and the equalization of the acid and alkali effects are characteristic of agar-protein mixtures and are in contrast with the reactions of the following test, in which the albumin was coagulated. As a result it no longer intermeshed with the agar in the gel, but aggregated as small particles, indifferent to the presence or proportion of water. A mixture of agar 95 parts and milk albumin 5 parts was prepared, in which the last-named substance dissolved in water was added to the melted agar at a temperature near 100° C., at which coagulation followed. The mixture, however, when poured on a glass plate, dried into a film about 0.13 mm. in thickness, which had a leathery texture and was transparent and appeared homogeneous. Sections swelled under the auxograph at 16° C. increased 261.5 per cent in distilled water, 346.2 per cent in hundredth-molar sodium hydroxid, and but 191.2 per cent in hundredth-normal citric acid. The proportions are in general accord with those obtained by swelling of agar alone, suggesting that the neutralized or coagulated albumen has no effect on the imbibition capacity of agar, in which it may be incorporated.

Other substances were next tested which are insoluble in water and hence might not be expected to enter into the two-phase system with agar. Mr. E. R. Long prepared some zein, a protmaine derived from *Zea mais*, at his laboratory at Seattle, Washington, early in July 1917, and this was made up with 1 part of zein to 9 of agar.

The fine, irregular particles, after being wetted, were stirred into the melted agar and the mixture was poured onto a glass slab and dried down to a thickness of about 0.3 mm. The plate was rough to the touch, the granular particles of the zein being distinctly visible as opaque masses. Sections tested under the auxograph gave the measurements as follows:

TABLE 5.

	<i>p. d.</i>
Water.....	1,033.3
Citric acid, 0.01 N.....	400
Sodium hydroxid, 0.01 M.....	350

The presence of the zein could not be said to be entirely without effect, as these measurements show some departure from agar in the relatively high swelling in acid. The imbibition in the hydroxid solution was extremely slow. Saturation was reached in 24 to 30 hours in water and acid, but enlargement continued for twice this period in hydroxid. All liquids were renewed at 36 hours. An acceleration ensued in hydroxid and the swelling was still in progress at the end of 48 hours, at which time the measurements were as above. Some of the equalization or increase in the swelling of the biocolloid in acid and its continued swelling in hydroxid is probably due to the fact that zein is slightly soluble in both acids and alkalies.

The addition of 1 part globulin from beans to 9 parts agar resulted in the formation of dried plates much like those of agar-zein. The globulin, not being soluble in water, was incorporated as small globular masses. Swellings of sections 0.2 mm. in thickness were exhibited as shown in table 6, at 16° C.

TABLE 6.

	<i>p. d.</i>
Distilled water.....	875
Potassium nitrate, 0.01 M.....	575
Potassium nitrate, citric acid, 0.01 N.....	550
Citric acid, 0.01 N.....	525
Potassium nitrate, potassium hydroxid, 0.01 M.....	450
Potassium hydroxid, 0.01 M.....	300

The proportionate imbibition in water, acid, and hydroxid is one characteristic of agar with a small proportion of protein. The solubility of globulin in salt solutions would lead to the expectancy that its presence would result in a modification of the swelling of agar in saline solutions.<sup>1</sup>

The "bean-protein" which has been used so extensively in these experiments is, as noted elsewhere, an extract with water in which the

<sup>1</sup> See Zsigmondy, Behavior of globulins, in chemistry of colloids, p. 222. 1917.  
Robertson, T. B. The physical chemistry of proteins. 1918. New York.

albumin, and some of the globulin, is dissolved in the water, which also contains the salts of the bean. The effects of albumin were tested separately, following the measurement of globulin effects, and the swellings of thin plates of 9 parts agar and 1 part albumin were as follows:

TABLE 7.

	<i>p. ct.</i>
Distilled water .....	1,158
Potassium nitrate, 0.01 M.....	947
Potassium nitrate, citric acid, 0.01 N.....	500
Citric acid, 0.01 N.....	421
Potassium nitrate, potassium hydroxid, 0.01 M.....	421
Potassium hydroxid, 0.01 M.....	316

The comparison of the above data with those obtained from the agar-globulin reveals the fact that while the globulin does not appear to increase the imbibition capacity of agar very much, the albumin does exercise such positive effect, the mixture showing a capacity three times as great as in acid or alkali. The swelling in acids is slightly greater than in alkalies, in accordance with the action of other mixtures of albumin. Imbibition by the globulin mixture in potassium nitrate is relatively high compared to water-effects, while it scarcely rises above that in acids. The swelling of the agar-albumin in this salt is more than twice that of acidified and alkaline salts, acids, and alkalies.

The presence of insoluble inclusions is of course the normal and usual condition in the cells of plants during extended periods, and it was desirable to ascertain whether or not material wholly neutral in biocolloidal plates would affect hydration. The first trial was made with a cotton lace about 1 cm. in width and 0.5 mm. in thickness. This was well softened, and when laid in the mold the warm colloidal mass was poured over it, accomplishing an intimate penetration among the smaller fibers of the threads.

The portion of a plate of agar and oat protein free from the webbing dried down to a thickness of 0.18 mm., and sections of this swelled 2,111 per cent in distilled water, while the increase in swamp water was 1,277 per cent. Sections containing webbing swelled 1,583 per cent in bog water and the same amount in distilled water, and 1,195 per cent in swamp water, calculated on the basis of the thickness of biocolloid noted above. It is by no means certain, however, that the colloid does dry in equal mass on the webbing. (See Chapter VI for discussion of bog water.)

Calculated in terms of actual thickness, the swelling of the webbed sections was 491 per cent in bog water and in distilled water, while it was but 371 per cent in swamp water. The presence of the webbing appears to diminish the proportion of swelling in distilled water and bog water, but not that in swamp water. Swamp water (see p. 68) contains an amount of calcium salts which notably affects swelling in clear sections. This operated to mask any effect due to the presence of the cotton fibers in colloidal sections.

Still another type of inclusion was tested by the incorporation of spores of *Lycopodium* in liquefied agar. These spores are not readily wetted, and hence they could be worked into a colloidal mixture only at low temperatures, when it was in a stage nearing gelation.

The first attempt was one in which 2.5 parts by weight of spores were mixed with 40 parts by dry weight of agar. The agar was liquefied in the usual manner, and when it had come down to a temperature of about 40 was strained through cheese cloth into a beaker. The quantity of spores given above was now placed on the surface and the whole was vigorously stirred for several minutes with an ordinary revolving egg-beater. The agitation was continued until the temperature fell to 35° C., when the whole was cast as a plate in the usual manner. The dried plate was 0.3 mm. in thickness and showed the spores and numerous clumps of spores embedded in it, with very few really coming to the surface. When sections of the ordinary size were cut and swelled at 18° C. they showed some buckling. The swellings in distilled water, and in asparagin 0.05 M were equivalent, being 850 per cent in 24 hours, with some increase still in progress, the rate being greater in distilled water.

The second test was arranged with sections 0.27 and 0.28 mm. in thickness, which swelled 1,125 per cent in 0.01 M asparagin and 667 per cent in acetic acid 0.01 N, both pairs of tests showing an expansion far less than might be expected from the agar alone. It seems quite safe to conclude that inclusions such as bodies of zein, globulin, coagulated albumin, fine threads of glass, cotton fibers, and spores lessen the hydration capacity of the gel in which they may be embedded. As their effects are due directly to the area of surface and radius of curvature, the action of a comparatively small amount of finely divided material would be very much greater in the cell. The foregoing results are in accordance with those of Hardy, who found that solids included in a colloid before fixation may influence the structure of films in a material manner. Grains of carmine incorporated in liquid colloids modified the mesh and the thickness of the plates or bars or more solid material, and the prevalence of insoluble particles in plant cells renders such observations of great interest.<sup>1</sup>

---

<sup>1</sup> Hardy, W. B. On the structure of cell protoplasm. *Journal of Physiology*, 24: 158. 1899. See p. 186.

### III. THE CONSTITUENTS OF BIOCOLLOIDS WHICH AFFECT HYDRATION AND GROWTH.

Some organs and cell-masses of plants as well as of animals display swelling reactions similar to those of gelatine with respect to acids and salts, and a great deal of discussion of the colloidal action of protoplasm has been based on the assumption that this parallelism runs throughout. That investigation should have taken this course is natural when it is recalled that gelatine, in common with proteins and many protein derivatives, is amphoteric, and may dissociate either as an acid or as a base, being stronger as an acid than as a base. In a condition of neutrality or at its iso-electric point its hydrogen-ion concentration is represented by the symbol  $\text{pH} = 4.7$ . It is to be seen that the diversity of hydration reactions which such substances may display might well give rise to the assumption in question. Furthermore, it is to be granted that some organs and cell-masses of animals as well as of plants are so high in nitrogenous compounds as to be characterized by the reactions of amphoteric colloids. Thus, for example, bacteria may contain so much nitrogenous material that the dried remainder obtained from them may appear to consist principally of albumin.<sup>1</sup>

It would be a mistake, however, to assume a close identity of the protoplasmic machine as to its colloidal components. The results described in the present work make it evident that it is a heterogeneous gel, which, in plants at least, is largely composed of inert or neutral carbohydrates of the pentosan group, of which agar, gum arabic, and mucilages are examples. The swelling or hydration of such gels is modified by the action of the proteins, amino-acids, and other nitrogenous substances which may be incorporated with them, but throughout all of my experimentation it was evident that the water-relations of growing plants were more of the character of pentosans than of gelatines.

Reproductive cells and elements of all kinds may be expected to prove high in nitrogen, and hence would show swelling reactions of the general nature of gelatine.<sup>2</sup> So well is this established that it is possible to predict the main facts as to nitrogen-content upon the basis of a series of swelling tests with distilled water, acids, and alkalies.

The relation of the nitrogen-content to swelling is well illustrated by some reactions of red algae of the Pacific Coast which were studied at the Coastal Laboratory, Carmel, California, in July and August 1917, by Dr. J. M. McGee.<sup>3</sup>

<sup>1</sup> Thompson, D. A. W. Growth and form, pp. 40 and 41. 1917. Cambridge Univ. Press.

<sup>2</sup> Lloyd, F. E. Colloidal phenomena in the protoplasm of pollen tubes. Report Dept. Bot. Research, Carnegie Inst. Wash. for 1917 (Year book No. 16). 1918.

<sup>3</sup> McGee, J. M. The imbibitional swelling of marine algae. *Plant World*, 21 : 13. 1918. Baltimore.

Trios of sections of the laminæ were swelled in various solutions and their increase registered by the auxograph. These marine algæ have a normal balance enabling them to exist in sea-water which contains about 3.50 per cent total salts. The effect of the various substances on imbibition in these plants was therefore obtained by adding them to sea-water in such quantities that they formed hundredth-molar solutions. The results with *Iridæa laminarioides* were as follows at 16° C.:

TABLE 8.

	<i>p. ct.</i>
Thickness, 0.4 mm.	
Sea-water + NaOH, 0.01 M.....	25
Sea-water + HCl, 0.01 M.....	31
KNO <sub>3</sub> + citric acid, 0.01 N.....	175

Young fronds of *Gigartina exasperata* gave average swellings as below at 16° C.:

TABLE 9.

	<i>p. ct.</i>
Sea-water, sodium hydroxid, 0.01 M.....	28
Sea-water, hydrochloric acid, 0.01 M.....	38
Potassium nitrate, citric acid, 0.01 N.....	142

Such reactions are indicative of a high proportion of amino-acids, which probably fell off toward maturity, and which may have been extracted by washing as sections which had been treated with distilled water, a treatment which would result in the extraction of some of the salts and the amino-acids. Such sections when dried to a thickness of 0.5 mm., gave swellings at 16° C. as follows:

TABLE 10.

	<i>p. ct.</i>
Distilled water.....	4,331
Hydrochloric acid, 0.01 M.....	2,967
Sodium hydroxid, 0.01 M.....	2,756

The analysis of the washed and dried material showed that it contained 68 per cent carbohydrates, 18 per cent gelatine-like material, and 14 per cent of salts. It is of interest to note that these algæ, which inhabit the shore, display a course of acidity through the day generally similar to that of other thick and succulent plants by which the acidity is highest in the morning, decreasing toward the end of the day, but sometimes rising before night.<sup>1</sup>

The vacuolar fluid of the plant-cell may be taken to carry minute quantities of the carbohydrates which enter into the protoplasmic gel at all times and, in addition, the sugars which figure so prominently in the metabolism of the plant. The mucilage and pentosans in general change but slowly and are to be considered as being of importance chiefly by reason of their properties and effects as constituents of the colloidal structure. The presence of sucrose and dextrose of course modifies the osmotic properties of the cell, and as these substances are

<sup>1</sup> Clark, Lois. Acidity of marine algæ. Puget Sound Marine Sta. Publ. 1, No. 22. 1917.

dissolved in the fluids which are imbibed by the gels, their probable influence is a matter of some importance. An examination of the effects of sucrose and dextrose on agar and gelatine and mixtures of these two substances was made by Dr. E. E. Free at the Coastal Laboratory, Carmel, California, in September 1916, and his results show no certain effect upon the hydration of gelatine, agar, and of mixtures of the two substances from water solutions containing as much as 25 per cent of sucrose or dextrose.<sup>1</sup> More recently, E. A. and H. T. Graham have found that glucose, saccharose, and lactose, when added to gelatine, retard the diffusion of such acids as hydrochloric, nitric, sulphuric, phosphoric, lactic, formic, acetic, and butyric, with an accompanying effect on the swelling. Diffusion was also found to be retarded by sodium chloride.<sup>2</sup> The universal presence of both sugars and salts in the plant cell gives great importance to the relations indicated.

Mucilages or pentosans are present in varying proportions in all plant cells, and it is the character and relative amounts of such compounds that largely determine the hydration reactions of the protoplast. Of these substances agar was used most generally throughout the experiments, because it goes into the disperse condition very slowly and in this particular is identical with protoplasmic gels.

According to information furnished by Mr. H. Nakano, of the Botanical Garden of Tokyo, agar is prepared chiefly from the algæ *Gelidium amansii* Lamour, *G. pacificum* Okam, *G. linoides* Kütz, *Pterocladia capillacea* Born. et Thur., while some material of *Gelidium subcostatum* Kütz, *Ceramium boydenii* Gepp., *Campylæphora hypenaloïdes* Y. Ag., *Acanthopeltis japonica* Okam, etc., may be included. The process includes washing in fresh water, decoloration in the sun, milling, boiling, filtering, maceration in sulphuric or acetic acid, freezing, and drying. Modernized methods simplify this treatment somewhat. Salts and nitrogen are present in the final product in minute quantities insufficient to affect hydration.<sup>3</sup>

Other gums and mucilages of this group which were tested included gum arabic or acacia, cherry gum, prosopis gum, tragacanth, and opuntia mucilage, all of which are more readily dispersible in water, but which do not go wholly into suspension even in prolonged immersion. The mucilages of the cacti are pentosans, or substances which yield hexose and pentose sugars on hydrolysis with dilute acids. Substances of a similar character formed by the condensation from simpler sugars may be taken to be universally present in plant cells, being aggregated in the plasmatic mesh, in which condition the muc-

<sup>1</sup> Free, E. E. Note on the swelling of gelatine and agar gels in solutions of sucrose and dextrose. *Science*, 46 : 142. 1917.

<sup>2</sup> Graham, E. A. and H. T. Retardation by sugars by diffusion of acids in gels. *Jour. Amer. Chem. Soc.* 40 : 1900. 1918.

<sup>3</sup> For further information concerning the origin and preparation of similar products, see Swartz, M. D. Nutrition investigations on the carbohydrates of lichens, algæ, and related substances. *Trans. Conn. Acad. of Arts and Sciences*, 16:247-382. Apr. 1911.



lages and gums elude microchemical tests. It has already been pointed out that it is in this condition that they produce the peculiar hydration properties of living matter which are those of an agar-protein gel.<sup>1</sup>

Generally the mucilages originate in minute quantities in numerous places in the protoplasm, but when such structures as starch-grains or layers of wall material are transformed, the gels so formed largely remains in place, and as they swell to occupy a much larger space than

TABLE 11.—*Hydration of sections containing gums and mucilages.*

	Distilled water.	Citric acid, 0.01 N.	Sodium hydroxid, 0.01 M.	Potassium nitrate, 0.01 M.
	<i>p. ct.</i>	<i>p. ct.</i>	<i>p. ct.</i>	<i>p. ct.</i>
Agar (17° C.).....	2,420	1,300	602	1,700
Agar 6, prosopis gum 2, gel. 1, bean protein 1 (25° C.).....	1,760	1,182	824	.....
Agar 6, gum arabic 3, gel. 1 (14-17° C.).....	{ 1,141 1,072	957 572	478 458	..... 1,250
Agar 8, cherry gum 2 (16° C.).....	{ 750 1,278	889 912	639 556	1,389 1,082
Agar 6, cherry gum 3, gel. 1 (16° C.).....	1,417	1,050	750	1,100
Agar 8, cherry gum (precip.), 2.....	2,020	1,100	520	1,268
Agar 8, gel. 2 (16° C.).....	1,684	947	474	1,347
Agar 8, tragacanth 2 (15° C.).....	2,178	1,367	778	1,725
Tragacanth (15° C.).....	{ 846 1,038	1,500 1,500	731 731	1,346 1,200
Opuntia mucilage (15° C.).....	900	650	350	300

	Water.	Hydrochloric acid, 0.01M.	Sodium hydroxid, 0.01M.
	<i>p. ct.</i>	<i>p. ct.</i>	<i>p. ct.</i>
Agar 6, opuntia mucilage 2, bean protein 1, gel. 1 (26-27° C.).....	1,780	780	1,060
(22° C.).....	2,400	900	950
Gelatine 90, cactus mucilage 10.....	500	806	562
	425	762	531
	400	806	575
	387	706	612
Average.....	428	770	557
Gelatine 100, agar 5, averages.....	329	850	685
Gelatine 80, agar 20, averages.....	431	789	431

that occupied by the bodies from which they were formed, the resultant masses may be so large as to crowd the protoplasm into a small compass.<sup>2</sup> Their hydration offers such indeterminate features as to make

<sup>1</sup>Spoehr, H. A. Carbohydrate economy of the cacti. Carnegie Inst. Wash. Pub. No. 287 pp. 44-47. 1919.

<sup>2</sup>Stewart, E. G. Mucilage or slime formation in the cacti. Bull. Torr. Bot. Club 46:175. 1919. Lloyd, F. E. The origin and nature of the mucilage in the cacti and in certain other plants. Amer. Jour. of Bot., 6:156. 1919.

it impossible to secure measurements by the methods which may be used with agar and with gelatine. Information as to their effects can only be obtained by observations on the action of mixtures of which they form a part. Table 11 includes some of the data as to the swelling of colloids, including pentosans secured in this laboratory.

It is also obvious that the addition of any of these gums or mucilages to agar tends to lessen swelling in water and to equalize the imbibition in water and in acids. Their general effect, however, when combined with nitrogenous substances, is to make a colloid which has a higher coefficient of swelling in water than in organic acids, although, as may be seen later, a special relation is sustained to the amino-acids.

The vacuolar fluid of the plant cell probably always contains some protein or its derivatives in the form of amino-acids, while various nitrogenous compounds have been identified in the nucleus and other bodies of morphological rank. The formation, disintegration, and migration of these substances from one part of the cell to another offers a most inviting field for the researcher concerned with the physics of the cell.

The proteinaceous substances are of course invariable constituents of the biocolloids of the plant protoplast. The varying reactions of such material to the hydrogen-ion concentration or acidity of solutions and to salts are exemplified in nearly every section of this work. Combinations of agar with protein extracts, with albumins, peptones, gelatine, and amino-acids were tested to such an extent that it is possible to say that the highest coefficients of hydration in water alone are exhibited by pentosan-albumin mixtures in which the substances of the first group form the greater part of the mixture. All such trials were with materials with possible physiological significance, especially in plants.

Many of the nitrogenous compounds used in making biocolloids in our tests are known to be actually present in the cell. The presence of one of them, peptone, in the nucleus is definitely established. A characteristic behavior of the mixtures containing such substances has already been noted (see MacDougal and Spoehr, *The effects of acids and salts on biocolloids*, *Science*, 46: 269. 1917). Increases of nearly 3,200 per cent in distilled water, 567 per cent in hundredth-molar hydrochloric acid, and the superior and long-continued swelling in hundredth-molar potassium hydroxid, which sometimes reached a total of nearly 1,700 per cent at room temperatures (20° to 28° C.), were the characteristic features. These figures were obtained by the use of sections consisting of 90 parts agar and 10 parts Witte's peptone.

The tests were repeated, using "Diffco" peptone in the same proportion and with temperature kept strictly at 15° C., and the records given below are all at the close of 22 hours. The measurements were as follows:

TABLE 12.

	<i>p. ct.</i>
Water.....	1,400
Potassium nitrate, 0.01 M.....	1,200
Potassium nitrate, citric acid, 0.01 N.....	900
Citric acid, 0.1 N.....	675
Potassium nitrate, potassium hydroxid, 0.01 M.....	575
Potassium hydroxid, 0.01 M.....	400

The hydration in all the solutions was less than in the earlier tests, partly due, no doubt, to the difference in the peptones used. The increase in hydroxid is small; no direct comparison can be made as to the acid, as a hundredth-normal solution was used in the other tests, while the swelling in acidified salt solutions is relatively large. Such results emphasize the fact that material standardized for cultural and chemical purposes may present differences in colloidal action of a serious character.

Nucleinic acid is a substance of interest in connection with its occurrence in the nucleus and its direct effect in simple combination was tested. A mixture of 90 parts agar and 10 parts nucleinic acid was dried into plates 0.2 mm. in thickness. Two series of sections were swelled in a dark room at 16° C., with the following results:

TABLE 13.

	<i>p. ct.</i>	<i>p. ct.</i>
Water.....	1,400	1,025
Potassium nitrate, 0.01 N.....	900	800
Potassium nitrate, citric acid, 0.01 N.....	650	675
Potassium nitrate, 0.01 N.....	850	750
Potassium citrate, citric acid, 0.01 N.....	725	.....
Citric acid, 0.01 N.....	700	625
Sodium hydroxid, 0.01 M.....	1,000	925

The action of this mixture fixes attention by reason of the extraordinarily high amount of swelling in the alkaline solution. The amount of swelling in acid does not average more than half that in distilled water. The behavior of nucleinic acid and of peptone when mixed with agar is such as to suggest that a study of the action of these substances when combined separately and together with agar would be of interest in connection with interpretations of nuclear phenomena.

The series of tests now including some data from mixtures of most of the albumin and protein derivatives which were available, it was deemed advisable to introduce more than one nitrogenous compound into the biocolloid. The first mixture contained 90 parts agar, 3 parts nucleinic acid, 3 parts peptone, and 4 parts of asparagine. The plates dried to a thickness of 0.2 mm. and sections were swelled in a room at 15° C. with the results as given in table 14.

The outstanding features in table 14 are the comparatively high amount of swelling in the salts. The expected high hydration in acid solutions is not exhibited.

TABLE 14.

	<i>p. ct.</i>
Water.....	1,025
Potassium nitrate, 0.0 M.....	950
Potassium nitrate, citric acid, 0.01 N.....	875
Citric acid, 0.01 N.....	850
Potassium nitrate, potassium hydroxid, 0.01 M.....	775
Potassium hydroxid, 0.01 M.....	575

The comparative test of the result of the inclusion of aspartic acid and of its amine, asparagine, in the biocolloid is important, because the amine is a noticeable constituent of plant cells, in which it is frequently abundant. The acid appears to be only sparingly soluble and in a plate of agar 90 parts and 10 of this acid aggregates as whitish lumps in the plate or as an efflorescence on the surface. Much of the last formation comes off, so that the proportions given above do not hold for the dried material. The asparagine forms clear plates with the agar. The swellings were as follows:

TABLE 15.

	Water.	Citric acid, 0.01 N.	Sodium hydroxid, 0.01 M.
	<i>p. ct.</i>	<i>p. ct.</i>	<i>p. ct.</i>
Agar, asparagine....	640	300	402
Agar, aspartic acid .	295.5	250	625

The asparagine mixture shows swellings in water, acids, and alkali not widely different in proportion from those in which proteids of the bean are used. The aspartic acid, in accordance with expectation, shows an amplitude of swelling characteristic of organic acids in the solution in both acid and distilled water as reagents. Neutralization by hydroxid, and the renewal of this reagent, was followed by greater swellings.

The introduction of a fat into a biocolloid was attempted with a preparation of lecithin (Merck) from eggs. An amount which would give a proportion of about 0.5 per cent was smeared as a coating on a glass stirring-rod. After half the contents of a flask containing a mixture of agar 90 parts and milk albumin 9.5 parts had been poured on a glass plate for drying, the remainder was stirred until all of the lecithin had dissolved from the rod. It was then poured on a glass slab to cool. Separate particles could not be distinguished with a hand lens, but the mixture had a brownish tinge. When the film had dried to a thickness of 0.2 mm. it was tested under auxographs at 16° to 18° C. and the swelling measurements given in table 16 obtained.

No distinct effect of the fatty substance can be detected in these reactions, nor were any departures discernible in another preparation containing 90 parts of agar, 9 parts of bean protein, and 1 of lecithin. The bean protein is a water extract of *Phaseolus vulgaris* containing the albumins and also the other proteins soluble in the salts present.

When such material is stirred into distilled water a clear solution is obtained. The mixture was added to the melted agar at about 30° C. An amount of lecithin (Merck) from eggs, supposed to be about a gram, was smeared on the outer wall of a thin vial. The vial was dropped into the warm mixture and shaken until it had nearly all passed into

TABLE 16.

	Water.	Citric acid, 0.01 N.	Sodium hydroxid, 0.01 N.
	<i>p. ct.</i>	<i>p. ct.</i>	<i>p. ct.</i>
	1,923	423	250
	1,150	200	423
Average.....	1,536	311	336
Averages of swelling of mixture lacking lecithin.....	1,791	333	336

the solution, giving it a brownish tinge. By another method the lecithin was smeared on the inner surface of a warmed flask. The agar-protein mixture was poured in at a temperature of about 45° to 50° C. and shaken until all of the lecithin had been taken up. Dried plates prepared in this way showed no important departure from the behavior of mixture without lecithin. A series of such swellings with a plate 0.47 mm. in thickness at 16° to 18° C. gave the following:

TABLE 17.

Water.....	<i>p. ct.</i>
Citric acid, 0.01 N.....	1,106
Sodium hydroxid, 0.01 M.....	329
	436

It is obvious that these crude tests by no means constitute an adequate trial of the effects of fats or lipins in hydration of living matter. The prominence of the lipoid theory of the cell-membrane and the weight of some of the arguments adduced in its support renders it highly important that refined methods of experimentation be used in incorporating a lipin colloid in pentosan-protein mixtures, the hydration of which might yield results of importance bearing on permeability.

In an effort to make a mixture bearing a closer resemblance to the general hydration relations of plant protoplasm, the following materials were assembled:

Agar 4.2 grams, which was liquefied in 160 c.c. of water at temperatures of about 100° C., oat protein 0.18 gram, and oat albumin 0.820 gram, were dissolved by shaking up with 50 c.c. cold water. After this had been done 0.2 gram of lanolin was put in a vessel with the dissolved albumin and warmed to about 35° C., being shaken vigorously at intervals. The agar was now strained through two layers of cheese cloth into a beaker and stirred until it came down to a temperature of about 40° C., when it was placed in an enameled cup suitable for the

action of an ordinary revolving egg-beater. The albumin-lanolin mixture was now added to the agar and it was stirred vigorously some time above 35° C., and when it had come down to 33° C. it was cast in two portions. One was on filter-paper which was stretched in the usual manner, and the other smaller lot on a glass plate. The mixture set in a few minutes, the room temperature being about 20° C. The plates as above came down to an average thickness of 0.2 mm., which were tested at a temperature of 18° C., swelling 2,100 per cent in distilled water and but 1,750 per cent in 0.01 M asparagine.

A conception of living matter as simply a two-phase colloid in which the main elements are distributed between the more liquid and the denser phases simply according to their physical properties may be sufficient to interpret certain general reactions, but one does not proceed very far with the actual mechanics of living matter until it is realized that specializations of various kinds come in. Attention has already been called to the varying proportion of proteins and their probable effect on hydration. According to Kite,<sup>1</sup> the vacuolar fluid of *Spirogyra* contains some proteins in a dissolved or disperse state, and this fluid is even higher in nitrogenous material in *Chara*. A doubtful amount of plasmatic material may be taken to be in a disperse condition in plants under ordinary conditions, and the heavier portions differ widely as to density or viscosity, the outer layer of the nucleus and of the cell being a gel of greater rigidity than the interior portions. The fact that "none of the cytoplasm goes into solution very readily even when cut into very minute pieces," as described by Kite with respect to *Spirogyra*, can not be taken to prove that protoplasm may not readily go into the disperse or liquid phase in the fluids of the cell. The pentosans may move slowly, but during the growth of the nucleus, water and other substances pass into it from the surrounding cytoplasm. Again, at other times, material may be seen to pass from the nucleus to the cytoplasm. Many of these phenomena may now be explained on known behavior of colloids, and the study of colloidal action promises to yield much additional information upon the movement and interaction of the parts of the protoplast.

Most of the variations in composition mentioned are illustrated in the structure of a single cell, and in the growth and development of these units the accumulation, migration, and disintegration of these substances may be definitely connected with the more important movements in the cell. The localization of salts is a matter which has been dealt with at great length by MacCallum, and the results which he has secured with a few of the more important salts afford a basis for some conception of the heterogeneity of the cell with regard to this feature.

---

<sup>1</sup> Kite, G. L. The physical properties of protoplasm of certain plant and animal cells. *Amer. Jour. of Physiol.*, 32:146, especially pp. 161 and 162. 1913. See also Conklin, E. G. Effects of centrifugal force on the structure and development of the eggs of *Crepidula*. *Jour. Exper. Zool.*, 22: Feb. 1917. See pp. 356-364.

Migrations of albuminous material from one part of the cell to another and translocation of the proteins is a subject upon which nearly all cytologists speak with great reserve because of the lack of well-grounded observations. An extensive examination of such action by the use of root-tips of *Vicia faba* has been made by Professor C. F. Hottes, of the University of Illinois, and some of his results as yet unpublished include facts of great possible importance. Dr. Hottes says<sup>1</sup> that seedlings deprived of the cotyledons and grown in the dark at 20° C., being supplied with nutrient salts and water, continued to grow for a period of three days to a week. The changes in the nucleus and the concomitant action of the cytoplasm during this time are very striking in the root-tips. The nucleolus is enormously reduced in size and its materials escape into the cytoplasm. Materials from distant cells, albuminous in nature, are transported through considerable distance to the meristem of the tip, and these cells remain alive, sustaining a parasitic relation to the cells from which the material has been derived, and the fundaments of lateral roots are broken down and translocated in the same manner. The progress of the translocation may be followed through the strands connecting with the tip meristem. Such transfer of materials is apparently inhibited at low and high temperatures which lessen or stop growth. Antipyrine accelerates exudation and transfer of such proteinaceous material and chloral hydrate inhibits it. Furthermore:

“In all treatments leading to inhibition of cell activity, I find enlargements of nucleolus, increase of chromatin without the passage of perceptible amounts of these materials into the cytoplasm. In cell acceleration the nucleolar material can be distinctly followed through the reticulum of the nucleus into the cytoplasm. The chromatin (tropochromata) fluctuates in quantity and its increase and decrease is concomitant with the absence and presence of chromatin (chromidia) in the cytoplasm.”

As the proteins diffuse sparingly,<sup>2</sup> their translocation in living matter must take place by some other method, and one by which a relatively rapid movement would be possible. So far as plants are concerned, the possibilities offered by the amino-acids may prove to be of the greatest importance in this connection. These substances pass through membranes, show a relatively high rate of diffusion, and are readily derived and combined.

---

<sup>1</sup> Letter to author.

<sup>2</sup> Robertson, T. B. *The physical chemistry of proteins.* New York. 1918. See p. 330.

#### IV. THE EFFECT OF SALTS AND ACIDS ON BIOCOLLOIDS AND CELL-MASSSES.

A proper supply of certain salts in the substratum is one of the most important requirements of the plant, and those known to the physiologist as necessary for growth and development are designated as "nutrient salts," although more properly to be designated as culture salts.

Available analyses show the general proportion of the various substances present in the organs and tissues of many kinds of plants. The specialized or localized accumulations in the regions of the cell have been demonstrated of only a very few substances, of which iron and potassium seem to be the most notable.<sup>1</sup> Chemical unions or precipitations may account for the local concentration in some cases, while in other structures the surface tensions of the minute masses of gels or liquid may be responsible.

The heterogeneous character of living matter and the known facts of its hydration and that of biocolloids by which water, acids, and salts, etc., enter into combination in both definite and indefinite proportions with the colloidal material, together with the behavior of cell-masses in imbibition, have made it seem inadvisable to attempt to express the reactions obtained in terms of hydrogen-ion or hydroxylion concentrations, and but few measurements of this kind are cited in the experiments described in the present paper. Although this method entails a treatment empirical to a certain extent, yet forced parallelisms and false explanations resulting from the application of simple formulæ to complex phenomena are avoided. Attention has been confined chiefly to the study of the action of solutions in which dissociation may be assumed to be complete or nearly so. By following this simplified procedure it has been possible to explore wide fields of biological possibilities, the exact mapping of which will need concentrated attention upon comparatively narrow problems. This is especially true of the action of the amino-compounds upon biocolloids, concerning which certain preliminary results are described in the following pages.

The amount of acid or salts and of water which may be taken up from a solution and the accompanying swelling is influenced by several factors. The reader is referred to texts on physics and on colloids for detailed discussions of adsorption equations and for information concerning the allowable generalizations concerning the relative amounts of material which may be taken up by a colloid from a solution system.

For the present some results recently obtained by Miss C. L. Carey and as yet unpublished will be of interest, as the absorption of water

---

<sup>1</sup> MacCallum, A. M. The distribution of potassium in animal and vegetable cells. *Jour. of Physiol.*, 32:95. 1905. Also, Presidential address, *Brit. Assoc. Adv. Sc., Report for 1910*, p. 744.



and hydrochloric acid taken from a solution by various materials comes within the range of this chapter. In these tests 3 to 6 grams of the substance or of the plant material were placed in a dish containing about 100 c.c. of the acid solution at 21° C. The results are given in table 18.

TABLE 18.—*Water absorbed from hydrochloric acid per gram dry substance.*

Material.	Concentration.			
	N 20.	N 10.	N 5.	N/2.
Agar 1	2.572	2.444		
Agar 2	4.281		3.487	3.571
Agar 3 (only one determination in each row for agar C)	4.273	3.917	3.570	3.461
Agar 4 (4 hours)		2.944		
Agar 4 (4 days)		3.693		
Agar 4 (7 days)		2.886		
Agar 4 (10 days)		2.678		
Agar 4 (14 days)		2.731		
Agar-gelatin	4.524	4.965	3.821	3.913
Casein (Case 1)	14.862	4.824	5.982	5.019
Lupinus albus coarctedus	1.894	1.504	1.514	1.602
Vicia faba coarctedus	1.894	1.763	1.112	1.079
Phaseolus lunatus coarctedus	1.164	1.151	1.257	1.210
Starch (commercial "best starch")	.922	.904	.786	.812
Casein (commercial shredded, after removal of oil and sugar)	5.824	5.891	5.645	5.678

The amount of acid absorbed was greatest in all cases from the highest concentrations used. The amount of hydration which accompanies the incorporation of the acids in the colloids is given in table 19.

TABLE 19.—*Absorption of hydrochloric acid and water from solution, per gram dry substance.*

Material.	Hydrochloric acid, grams.				Water, grams.			
	N 20.	N 10.	N 5.	N 2.	N/20.	N/10.	N/5.	N/2.
Agar 1	0.0115	0.1561			2.8122	1.64		
Agar 2	0.1177		0.0516	0.0690	4.242		3.487	3.571
Agar 3 (only one determination in each concentration for agar C)	0.1331	0.2151	0.3457	0.6892	4.2753	3.9173	3.5703	3.461
Agar 4 (4 hours, 4 determinations)		0.1735				2.944		
Agar 4 (4 days, 2 determinations)		0.1913				3.693		
Agar 4 (7 days, 2 determinations)		0.1476				2.886		
Agar 4 (10 days, 2 determinations)		0.1386				2.678		
Agar 4 (14 days, 2 determinations)		0.1373				2.731		
Agar-gelatin	0.1941	0.2508	0.3433	0.7705	4.5204	4.9653	3.8213	3.913
Casein (Case 1)	0.4130	0.5577	0.6991	1.1075	14.8629	4.8243	5.9825	5.019
Lupinus albus coarctedus	0.0843	0.1700	0.2490	0.4173	1.8061	1.5041	1.5141	1.602
Vicia faba coarctedus	0.1269	0.1918	0.2636	0.3191	1.0961	1.1631	1.1121	1.079
Phaseolus lunatus coarctedus	0.1256	0.1996	0.2672	0.3482	1.1601	1.1511	1.2571	1.210
Starch (commercial)	0.0259	0.0442	0.0779	0.1434	0.8220	0.8040	0.7860	0.812
Casein (commercial shredded, after removal of sugar and oil)	0.2344	0.3585	0.4789	0.9669	5.8245	5.8915	5.6455	5.678

Briefly summarized, agar takes up the greatest amount of water in 24 hours from a 0.05 N solution, and the maximum imbibition in gelatine and gelatine-agar combinations also ensues in this concentration, which is one duplicated in the cell-masses of the plant. Cotyledons and sections of the plants tested found their maximum at a concentration of 0.1 N at the temperatures named.

Hydration of dried plates, or of sections of living plants, is, of course, accompanied by a diffusion or solution out of the contained salts in a manner determined by a large number of environmental conditions, inclusive of the proportionate amount of water to which the colloid is exposed or in which it may be immersed.

Thus, in most of the experiments described in this volume, the sections having a total initial volume of dried material of about 2 or 3 c. mm. were immersed in dishes containing 33 c. c. of water. The hydration of material over a period of 24 to 50 hours would necessarily result in the solution out of a portion of the salt contained, which might form as much as 18 per cent of the original dried weight of the sections. On the other hand, swelling in a solution of salt-free colloid, for example, might result in an accumulation.

A series of tests was made to ascertain the relative amounts of water which might be taken up by one of the biocolloids used extensively in this work from a graded series of a salt solution. Since it showed a maximum hydration capacity at temperatures of 15° to 40° C., a mixture of agar 90 parts and oat protein 10 parts was used, and the sections, which ranged from 0.16 to 0.18 mm. in thickness, were measured as to each set and arranged in trios in glass dishes. The sections were as nearly uniform as possible and the average volume of the air-dry trios of sections in each dish was 12 c. mm. The testing dishes held 30 c. c. of the salt solution. Temperatures were taken by means of small thermometers of the clinical type, and readings of the temperature of the solution in the dishes were made several times during the course of the test. It is to be noted that the end-point of the swellings would not have been reached until after 40 to 48 hours in the less-concentrated solutions, but the amount of expansion which might have been displayed in the last 12 hours of this period would not have changed the totals greatly or the proportions in any important manner. The data given in table 20 represent the average expansion of sets of 3 sections at 16° to 17° C.

TABLE 20.—Swelling of a mixture of agar 90 parts and oat protein 10 parts in distilled water and potassium nitrate at 16° to 17° C.

Potassium nitrate.	
	<i>p. ct</i>
2 M.....	445
1 M.....	640
0.5 M.....	530
.1 M.....	695
.05 M.....	860
.02 M.....	1,165
.01 M.....	1,305
.005 M.....	1,560
.0025 M.....	1,670
.00125 M.....	1,500
.000625 M.....	1,670
.0003125 M...	1,720
Distilled water	1,940

The range of concentrations examined does not exhaust the possibilities. It has been previously found that biocolloids will take up some water and swell from the most concentrated mixtures of salts. On the other hand, the greatest attenuations exerted some influence on the water capacity, although it may be surmised that at a lower concentration the deviation on the swelling in the salt solution from that in distilled water would be so slight as to be negligible in all biological applications of the facts. Living matter is at all times impregnated with salts to a degree within the range of these tests.

In the continuance of the series to test the effects of some of the salts of biological importance, plates of agar and oat protein 0.2 mm. in thickness were swelled at 15° C. in calcium nitrate. Two series of measurements are shown in table 21.

TABLE 21.

Calcium nitrate.		
	<i>p. cl.</i>	<i>p. cl.</i>
2 M.....	975	917
0.2 M...	525	722
.02 M..	650	778
.002 M.	1,425	1,555
.0002 M	1,975	.....

The weakest attenuation used allows a swelling practically equivalent to that of distilled water. Two series of greatest divergence from the effects of potassium nitrate are to be found in dilutions of 0.02 M, while distinctly different action is seen to prevail in the concentrated solutions above the unimolecular.

The sections of agar-oat protein used for testing the effects of calcium chloride were 0.16 mm. in thickness and the swelling was made at the same temperature as in potassium nitrate, 15° C. The measurements in 24 hours are given in table 22.

TABLE 22.

Calcium chloride.		
	<i>p. cl.</i>	<i>p. cl.</i>
Distilled water.	1,660	.....
2 M.....	273	.....
1 M.....	375	.....
0.1 M.....	656	.....
.01 M.....	907	.....
.005 M.....	1,279	.....
.001 M.....	1,281	.....
.0002 M.....	1,469	1,438
.00005 M....	1,438	1,688

TABLE 23.

Potassium chloride.			Water.	
	<i>p. cl.</i>	<i>p. cl.</i>	<i>p. cl.</i>	<i>p. cl.</i>
2 M.....	468	.....	.....	1,781
1 M.....	656	.....	.....	1,989
0.1 M.....	1,031	.....	.....	.....
.01 M.....	1,344	.....	.....	.....
.005 M...	1,156	.....	.....	.....
.001 M...	1,906	1,463	1,467	.....
.0002 M..	2,210	1,625	1,667	.....
.00005 M.	1,406	1,719	1,533	.....

The chloride of calcium appears to limit swelling to a greater extent than the nitrate, so far as table 22 is comparable with that obtained from swelling in the nitrate.

The next trial was made with potassium chloride in solutions of the same concentration as above. Agar-oat protein was used and the swellings at 15° C. in 24 hours are given in table 23.

The amount of imbibition in potassium chloride is greater than that in calcium chloride in equivalent concentrations, while it is noticeable

that in the 0.0002 M solutions here, as in some of the trials previously made, the swelling is very high, probably even higher than that in distilled water.

Swellings of the agar-oat-protein mixture for 24 hours at 15° C. gave the results shown in table 24 in di-potassic phosphate ( $K_2HPO_4$ ).

The sections in the 1 M solution were sealed by the glass triangle, which was pressed too closely on them, with the result that swelling progressed very slowly to a defective total.

If the results of the swelling in the di-potassic phosphate were plotted as a graph, it would be seen that the steepest part of the curve would lie in the region between the concentrations of 0.01 M and 0.005 M. The graph of the potassium chloride would be a much more regular figure. The steepest part of the graph of the results with calcium chloride would probably lie between 0.01 N and 0.005 N, the steepest part of the graph of calcium nitrate would probably be in the region between 0.02 N and 0.002 N, and the steepest part of the line expressing the falling-off of the retarding action of potassium nitrate would be between 0.05 N and 0.005 N.

The breaks or discontinuities in the rise of the curve of imbibition total led to the belief that some errors had crept in, and repetitions were made with concentrations from 0.01 M to 0.000005 M. The additional experiments were for the most part symmetrical with each other, although it is not allowable to contrast the separate items of the swellings of two different lots of material. The ground at first taken, that in minute quantities some of these salts might cause a swelling in excess over that in distilled water, still lacks confirmation. It is a matter, however, that should be tested with great care, as such reactions for sections of plants are included in my records.

The swelling in various concentrations of a salt supposedly depends chiefly upon the acid ion, although the action of the basic ions is not actually excluded. The above tests were made in solutions varying from 4 M to 0.5 M, which are far too concentrated to be of direct biological interest. A more dilute series of potassium salts in 0.01 M and 0.001 M solutions was made up and the swelling of sections of agar 90 parts and peptone 10 parts, 0.22 mm. in thickness, were made at 15° C. The tests were closed at the end of 24 hours, and although some slight increase was still in progress, the relations of the various preparations were identical with those which might be expected of the end-points. (Table 25.)

According to Hofmeister, as cited by Taylor, swellings of gelatine in chlorides and nitrates should be greater than in the citrates and

TABLE 24.

Di-potassic phosphate.	
	<i>p. d.</i>
Distilled water . . . . .	.....
2 M . . . . .	156
1 M . . . . .	125
0.1 M . . . . .	625
.01 M . . . . .	806
.005 M . . . . .	1,563
.001 M . . . . .	1,719
.0002 M . . . . .	1,899
00005 M . . . . .	1,964

sulphates. The differences found in my own tests with the above mixtures, which, it must be pointed out, are so small as to be very close to the limit of variation, are of the reverse kind. They are, however, of such a nature as to warrant the assertion that the greatest swelling of this biocolloid in the group of substances named does not take place in the nitrates and chlorides.

Another aspect of this matter was tested by arranging a series in which an agar-peptone mixture was swelled in two concentrations of sodium acetate, which is reputed to retard imbibition in simple colloids, and sodium chloride, which is said to increase the amount of swelling over that of water. The measurements of such swellings at 15° C., closed at the end of 24 hours, are given in table 26.

These results are featureless, so far as the above point is concerned. The lesser concentration of the sodium acetate seems to give a greater swelling than the higher, but, on the other hand, the sodium chloride, which should promote imbibition, does not induce swelling as great as those in the acetate. The sections used were salt-free and a parallel series was run, using dried sections taken from the median layer of *Opuntia* joints, which at 15° C. gave the measurements shown in table 27.

TABLE 25.

	Concentration.	
	0.01 M.	0.001 M.
Chloride....	<i>p. ct.</i> 818	<i>p. ct.</i> 1,136
Nitrate.....	818	1,206
Phosphate..	932	1,136
Citrate.....	977	1,227
Sulphate....	975	1,250

<sup>1</sup>Estimated from 0.007 M.

TABLE 26.

	Concentration.	
	0.01 M.	0.001 M.
	<i>p. ct.</i>	<i>p. ct.</i>
Sodium acetate..	1,167	1,262
Sodium chloride.	1,214	1,214

TABLE 27.

	Concentration.	
	0.01 M.	0.001 M.
	<i>p. ct.</i>	<i>p. ct.</i>
Sodium acetate..	650	613
Sodium chloride..	613	588
Distilled water...	570	.....

The swelling in both salts is greater at the higher concentration, and the maximum effect may lie at a higher point. The acetate induces a higher hydration effect than the chloride. The plant sections are of course extremely complex as to chemical composition, although their relations to water are taken to be chiefly determined by the pentosan-protein ratio, and are modified by the salts already present and by the residual acidity. It is evident that gelatine and isinglass do not furnish conditions for swelling analogous to those of the plant, as assumed by so many writers, since the results given above do not coincide in the main with those obtained by Hofmeister.<sup>1</sup> As has been pointed out elsewhere in this work, the similarity of action of the plant to that

<sup>1</sup> Hofmeister, F. Die Betheiligung gelöster Stoffe an Quellungs-vorgänge. *Archiv. f. Exper. Pathol. u. Pharm.*, 27: 395, 1890, and 28: 210, 233, 1891.

of gelatine and of the proteins and their derivatives will depend chiefly upon the proportions of such substances in the living cell-masses. The properties of gelatine may illustrate those of protoplasm only in so far as they are general to the elastic gels, in which class of colloids both may be included.<sup>1</sup>

The salt-content of colloids of living matter in all probability changes very slowly, while the acidity may vary with great rapidity and through a wide range. A set of tests were therefore arranged in which the salt-content would remain constant while the solutions contained a series of acid concentrations. The first series was one in which the salt was dissolved in the solution of the acid after the manner in which many measurements have been previously made. Sections of plates of agar 90 parts and oat protein 10 parts which had an average thickness of 0.18 mm. were cut so that a trio had a total volume when air-dry of 12 cu. mm. and the dishes in which these were placed held about 30 c. c. of the solution. These measurements were made with the solutions standing at 16° to 17° C. The results were as follows:

TABLE 28.

	<i>p. ct.</i>
Distilled water.....	1,722
Potassium nitrate, 0.01 M .....	1,250
Potassium nitrate, 0.01 M + citric acid, 0.05 N .....	472
Potassium nitrate, 0.01 M + citric acid, 0.01 N.....	528
Potassium nitrate, 0.01 M + citric acid, 0.005 N .....	667
Potassium nitrate, 0.01 M + citric acid, 0.001 N.....	944
Potassium nitrate, 0.01 M + citric acid, 0.0002 N.....	1,065
Potassium nitrate, 0.01 M + citric acid, 0.00004 N.....	1,139

The above measurements were taken at the end of 24 hours, at which time the sections in distilled water and in the two solutions containing least acid were still slowly expanding, at a rate which would not have changed the final aspect of the test. These results are of importance, since it has been found that the range of acidity in such plants as growing joints of cacti may be practically equivalent to that from the highest acid-content to the lowest during the daylight period, coincident with an enormous variation in the water-capacity of the organ.<sup>2</sup> The measurements of plates composed of 90 parts agar and 10 parts bean protein 0.25 mm. in thickness, in dark room, at 16° to 17° C., gave the results shown in table 29.

TABLE 29.

	<i>p. ct.</i>
Distilled water.....	1,280
Potassium nitrate.....	1,060
Potassium nitrate, citric acid, 0.01 M .....	802
Citric acid, 0.01 N.....	604
Potassium hydroxid, 0.01 M.....	604

Effects similar to the original are to be discerned in the above. The combination of acid and salt reduces the hydration capacity of the

<sup>1</sup> Fenn, W. O. Similarity in the behavior of protoplasm and gelatine. *Proc. Nat. Acad. Sci.*, 2: 539. 1916.

<sup>2</sup> MacDougal, D. T., and H. A. Spoehr. The effects of acids and salts on biocolloids. *Science*, 46: 269. 1917.

colloid below that in the salt alone. A wide variety of tests which gave opportunity for comparisons are described throughout this volume, but a few may be recorded here which were carried out expressly to obtain evidence on this point with biocolloids of different constitution.

Nucleinic acid is a constituent of the nucleus, and as the only other substance from this body which had been introduced into the tests which could be assigned to the nucleus was peptone, its swelling reactions were tested with much interest. The results of swellings of these substances, when combined in proportion of 10 parts nucleinic acid to 90 parts agar, are given in table 30.

TABLE 30.

	<i>p. cl.</i>	<i>p. cl.</i>
Distilled water.....	1,400	1,025
Potassium nitrate, 0.01 M.....	909	800
Potassium nitrate, citric acid, 0.01 N.....	650	675
Potassium citrate, 0.01 N.....	850	750
Potassium citrate, citric acid, 0.01 N.....	725	.....
Citric acid, 0.01 N.....	700	625
Sodium hydroxid, 0.01 M.....	1,000	925

A second series a week later gave measurements shown in table 31.

TABLE 31.

	<i>p. cl.</i>	<i>p. cl.</i>
Distilled water.....	950	1,100
Potassium nitrate, 0.01 M.....	650	550
Potassium nitrate, citric acid, 0.01 N.....	575	500
Citric acid, 0.01 N.....	575	450
Potassium nitrate, potassium hydroxid, 0.01 N.....	900	750
Potassium hydroxid, 0.01 M.....	850	800

This mixture is seen to swell most in distilled water, while the proportionate swelling in hydroxid is very high, being greater than that in the salts tested or in acid. Next, it is apparent that the two potassium salts produce or allow an amount of imbibition not very much short of that in the hydroxid. The acidification of the salts practically reduces the swelling to the proportion displayed by the acid alone. This must be taken to apply to this set of combinations only. It may not be assumed that a similar generalization would hold for calcium.

Following the above, plates composed of 90 parts agar and 10 parts glycocoll, 0.15 mm. in thickness, were tested in series parallel to the above in the dark chamber at 16° C. The swellings are given in table 32.

TABLE 32.

	<i>p. cl.</i>	<i>p. cl.</i>
Distilled water.....	1,300	1,266
Potassium nitrate, 0.01 M.....	700	1,000
Potassium nitrate, nitric acid, 0.01 N.....	900	766
Citric acid, 0.01 N.....	666	766
Sodium hydroxid, 0.01 M.....	366	300

The effects of the acidified salt and of the acid are of the kind previously noted. The most prominent feature of the reactions was the low hydration capacity in the alkaline solution and the relatively high

expansion in acids, the action of the solution being supplemented by the amino-acid in the sections, in a manner similar to that of such other amino-acids as aspartic acid, cystin, tyrosin, etc.

A mixture of agar (50 parts) and gelatine (50 parts) poured on Pratt-Dumas brown filter-paper dried to a total thickness of 0.3 mm. Swellings of this were made in the dark chamber at a temperature of 16° C., with the results shown in table 33.

TABLE 33.

	<i>p. ct.</i>
Distilled water.....	400
Potassium nitrate.....	375
Potassium nitrate, citric acid, 0.01 M.....	350
Citric acid, 0.01 N.....	300
Potassium hydrate, potassium nitrate, 0.01 M.....	425
Potassium hydroxid, 0.01 M.....	325

These results, so far as they may be correlated with the earlier ones, show an unexpected relation to acid, hydroxid, and water. It is to be noted in addition, however, that a combination of potassium hydrate and potassium nitrate gives the maximum effect in the series.

The application of parallel tests to growing tissues is complicated by the fact that varying quantities of normal salts and acid salts may be present, giving a buffer effect. The concentration of the hydrogen ion may be determinable by estimation of the titrable acid and the dissociated malates, for example, as found by Jenny Hempel, but in addition there are to be considered the effects of the amino-acids and amines, which are not easily to be measured.

Leaves of *Mesembryanthemum edule*, which were not yet fully grown, were cut into sections about a centimeter long and allowed to dry in the air. When the greater part of the water had been lost and the sections had a leathery consistency, one of the angles was removed with the scissors, leaving a specimen 1.8 mm. thick. The preparations were by no means uniform. The use of three to obtain each record would tend to obviate or smooth the discrepancies, but the data given in table 34 can not be taken as having been obtained from preparations strictly equivalent.

TABLE 34.—Swelling of sections of *Mesembryanthemum*.

	<i>p. ct.</i>
Distilled water.....	72
Potassium nitrate, 0.01 M.....	69
Potassium nitrate, 0.1 M.....	56
Citric acid, potassium nitrate, 0.01 M.....	44
Citric acid, 0.01 N.....	72
Sodium hydroxid, 0.01 M.....	28

The main interest in this set of reactions is that directed to the comparison of the swellings in potassium nitrate, citric acid, and the combination at the same concentration. The coefficient of swelling in the plant-like sections of agar-oat protein and agar-bean protein was least in the acidified salt solution, although the hydrogen-ion concen-



tration of the combined solution should be equivalent to that of the salt alone. The combination of citric acid and potassium nitrate is open to some objection, but the effects described are similar to those obtained by the use of potassium chloride and hydrochloric acid.

The total acidity of pure juice of fresh material at Tucson varied from 0.0280 in the morning to 0.0232 per centimeter 0.01 N of sodium hydroxid at 4<sup>h</sup>30<sup>m</sup> p. m. Probably some of the acid was broken up during the drying, but the cell colloids would still be decidedly acid. The hydrogen-ion concentration in another species of *Mesembryanthemum* determined by Lakmoid tests and electrometer measurements by Hempel gave values of pH—4.8 to 5.2 for the first and 4.61 to 4.84 by the second method.

The matter was given further test by taking sections of young leaves in a flaccid condition and measuring the total swellings, which are given in table 35.

TABLE 35.

	p. ct.
Water.....	22
Potassium nitrate, 0.01 M.....	22
Potassium nitrate, citric acid, 0.01 N.....	17
Citric acid, 0.01 N.....	17
Sodium hydroxid.....	11

The swelling in potassium nitrate agreed with that of the dried material in being nearly equivalent to that in distilled water, and less in acid salt solution, but the swelling in acid is less, the proportionate swelling in hydroxid being about the same.

The effects of a similar series of reagents were tried upon disks from growing joints of *Opuntia*, with the results given in table 36.

TABLE 36.

	p. ct.
Distilled water.....	11
Potassium nitrate, 0.01 M.....	9
Potassium nitrate, citric acid, 0.01 N.....	10
Citric acid, 0.01 N.....	9
Potassium nitrate, potassium hydroxid, 0.01 M.....	10

The relations here are different in character from those exhibited by the material previously examined, but the departures are so small that no safe conclusion may be founded on them.

The incorporation of any salt with a colloid in the disperse phase would of course allow the formation of adsorption compounds to an extent and of a kind not possible when the salt enters the hydrating gel in a solution. The hydration of such a salted colloid might be expected to take place at a different rate and to a total varying from that of the unsalted colloid with unsatisfied chemical affinities and under the conditions of surface tension which would prevail.<sup>1</sup>

<sup>1</sup> Loeb, J. The similarity of the action of salts upon the swelling of animal membranes and of powdered colloids. Jour. Biol. Chem., 31: 343. 1917.

The first tests of the effects of incorporated salts were those in which the conditions of the plant were simulated, and the most rational procedure seemed to be one in which the culture salts of plants should be added to a mixture of agar and bean protein, the proportions being as follows:

TABLE 37.

Agar.....	gm.
Bean protein.....	9
Potassium nitrate.....	1
Potassium nitrate.....	0.00506
Di-potassic phosphate.....	.01622
Magnesium sulphate.....	.03660
Calcium nitrate.....	.03490
Total.....	10.09278

This material was reduced to a dried plate 0.18 mm. in thickness, which was swelled under the auxograph at a temperature of 15° C., giving increases of 1,400 to 1,500 per cent in distilled water, as might be contrasted with 2,100 to about 2,600 per cent in the reactions of similar sections free from salts.

A second preparation was made, but with ten times the amount of salt used in the first one, the salts forming nearly 9 per cent of the dry weight in one case and 0.85 per cent in the other. The swellings of the biocolloid with the higher salt-content are given below:

TABLE 38.

Distilled water.....	p. ct.
Citric acid.....	958
Potassium hydroxid,.....	361
Potassium nitrate, citric acid, 0.01 N.....	528
Potassium nitrate, 0.01 M.....	389
Potassium nitrate, 0.01 M.....	694
Potassium hydroxid, potassium nitrate, 0.01 M.....	472

The large proportion of salts is seen to hinder swelling in a notable manner. Temperature effects are of great importance in this connection, as it was found that sections of the plates which contained the lesser proportion of culture salts and which increased 1,325 per cent in distilled water at 15° C., swelled 2,666 per cent at 48° to 40° C. (See Chapter IX for a fuller discussion of temperature effects.)

Another set of dried plates was made for the purpose of obtaining comparisons in two directions. The colloidal constituents of the mixture were extended to include agar 70, dextrose 5, gelatine 5, peptone 5, asparagine 5, nucleinic acid 5, and bean protein 5 parts, and a set of dried plates was made up as above in distilled water. A second set was made up in the culture solution, in which the salts amounted to 0.85 per cent of the dry weight. The swellings were made on two successive days in a chamber constant at 15° C. It is to be noted that in any inspection of these results rigid comparisons may not be allowed between the swellings of the two kinds of plates in any solution. The basis of all comparisons must be the ratio of the swelling of each plate in any solution to its swelling in distilled water. (See table 39).

TABLE 39.

	Salt-free.	Salted.
	<i>p. ct.</i>	<i>p. ct.</i>
Distilled water.....	1,250	500
Potassium nitroxid, 0.01 M.....	875	550
Potassium nitroxid, citric acid, 0.01 N.....	535	425
Citric acid 0.01 N.....	446	425
Potassium hydroxid, potassium nitrate, 0.01 M.....	750	550
Potassium hydroxid, 0.01 M.....	535	525

The relative swellings of the biocolloid without the culture salts presents the general features of such mixtures, being highest in distilled water, next in potassium nitrate, less in acidified potassium nitrate, less in citric acid, and varying in the relations of the hydroxid and the alkaline salts.

The plates in which the culture salts were incorporated showed relative swellings which did not differ widely from the expectancy, except in the swelling in alkali and alkaline salts. The addition of the dextrose could not be seen to exert any definite action. The outstanding fact is the general retarding effect of salinity on the hydration capacity, a fact of possible enormous importance in the organism.

A mixture including 4 parts of agar, 5 parts of gum arabic, and 1 part of gelatine was made and sufficient potassium chloride was added to make it 0.01 M of this compound. Swellings at 18° to 20° C. were as given in table 40.

TABLE 40.

	<i>p. ct.</i>
Distilled water.....	512
Citric acid, 0.01 N.....	465
Sodium hydroxid, 0.01 M.....	214
Hydrochloric acid 0.01 M.....	535
Hydrochloric acid, potassium chloride, 0.01 M.....	419

A general restriction of nearly all of the swelling reactions is illustrated by the measurements in table 40, while the relative increase in acids is high.

As a further combination of two forms of carbohydrate, albumen, amino-acids, and of the salts which are found in plants, a mixture was made which contained the following material:

TABLE 41.

	<i>gm.</i>
Agar.....	6
Acacia.....	2
Gelatine.....	1
Albumin ( <i>Phaseolus</i> ).....	1
Potassium nitrate.....	0.0058
Potassic phosphate, dibasic.....	.0185
Magnesium sulphate (7H <sub>2</sub> O).....	.0418
Calcium nitrate (4H <sub>2</sub> O).....	.0398
Total colloid material.....	10
Total nutrient salts.....	.0105

Dried plates were made up in the usual manner and freed from water in a special chamber with fan at a temperature of about 16° C. Swellings at 14° to 17° C. were as shown in table 42.

TABLE 42.		<i>p. ct.</i>	<i>p. ct.</i>
Distilled water.....		2,200	2,240
Citric acid 0.01 N.....		802	880
Sodium hydrate, 0.01 M.....		602	680
Potassium chloride, hydrochloric acid, 0.01 M.....		700	640

The notable feature is the high swelling in water and the fact that the increase in the acid solution is less than in the alkaline, facts which are probably due in part to the action of gum acacia. This set of swellings has unusual interest because of its composition, in which the categories of substances in the plant are represented with some fairness and adequacy (fig. 9).

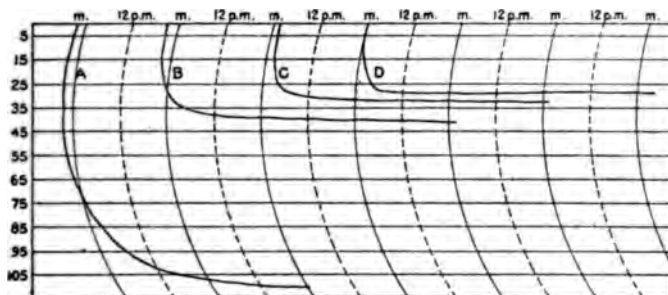

FIG. 9.  
Tracing of auxographic records of swelling of sections of plates consisting of 6 parts agar, 2 parts gum arabic, 1 part gelatine, 1 of bean albumin and .05 nutrient salts in water. A, citric acid .01 N. B, sodium hydrate, .01 M. C, potassium chloride and hydrochloric acid .01 M. D, at 14° to 17° C. Downward course of pen tracing denotes increase as indicated by numerals on margin.

The results obtained in some of the foregoing experiments indicated that the treatment of the biocolloid with salts before acid solutions were applied might show some features of importance, and this was also supported by the alternating effects described in detail elsewhere in this volume. Plates had been made of agar 90 parts and bean protein 10 parts in two sets. In one a culture solution was used in such concentration that the included salts formed 0.85 per cent of the dry weight of the sections. In the other the concentration of the salts was about ten times this amount. Both showed opaque dots or minute regions, supposedly insoluble globulin.

Swellings were made at temperatures of 16° to 17° C. on October 12 and 13, 1917, and the measurements obtained from the sections containing the larger proportion of salts are as given in table 43.

TABLE 43.		<i>p. ct.</i>
Distilled water.....		522
Citric acid, 0.05 N.....		583
Citric acid, 0.05 N.....		413
Citric acid, 0.0005 N.....		348
Citric acid, 0.00005 N.....		500

The measurements in table 43 were taken at the end of 30 hours, at which time expansion was not complete, although further swelling would not materially alter the relative values. The proportion of salts actually present was about one-twelfth of the biocolloid, which in volume amounted to about 12 c. mm. The dishes held 30 c. c., and from these data it may be possible to calculate proportions of salts and acids for comparison with the cases in which the salts are applied in solution.

A second test was made with the same biocolloid as above, but to which had been added but one-tenth of the foregoing proportion of culture salts. The plates were thinner, but the swellings were made at the same temperatures and under approximately the same conditions, with results as follows:

TABLE 44.

	<i>p. ct.</i>
Distilled water.....	1,667
Citric acid, 0.05 N.....	667
Citric acid, 0.005 N.....	899
Citric acid, 0.0005 N.....	1,139
Citric acid, 0.00005 N.....	1,500

The swelling of these plates, which were 0.18 mm. in thickness, was carried out at a temperature of 16° to 17° C., and the expansion in distilled water shows the retarding effect of the salt alone when comparison is made with agar-bean protein mixtures not treated with the nutrient solution. The citric acid in its heaviest concentration is equivalent to the strongest solution encountered in plants in this work, at which it is seen to retard swelling very much. Reduction of the concentration of the salts seems to be followed by a proportionate increase of water-capacity, in a fairly regular manner. The discrepancy in the swelling in 0.005 N acid in the more heavily salted plates is probably an instrumental error and will be so considered until confirmed. In the most attenuated solution of acid the swelling approaches that of distilled water, in which the salt effect alone is apparent.

The series of increases of a biocolloid given on page 48 present the general differences and relations of sections from plants, and these, rather than the one in table 44, which has such a high swelling coefficient in water, are of the character more usually encountered in cell-masses. It is to be recalled, however, that the composition of the biocolloid, including a mucilage, albumin, and amino-acids, is one which may well be duplicated in the plant, and it may be the recurrence of such combinations which would furnish the phenomena so prominent in the involutions of the cell.

The principal deductions of the present work support the conclusion that agencies or conditions which increase the hydration capacity of protoplasm accelerate growth, and any factor which tends to lessen either the rate of absorption or the total hydration capacity of living

matter retards and limits growth and development, or may have such special effects as, for example, the condensation of chromatin into special masses or chromosomes in the course of cell division.<sup>1</sup> Now, protoplasm parallels the colloidal action of gelatine only in so far as it is composed of protein or protein derivatives, and the proportions of these substances and of the associated carbohydrates vary from organ to organ and with the course of the seasons or the stage of development. Furthermore, the biocolloids of the cell are acidified or salted, and their behavior toward any reagent externally applied will of course be determined or modified by all of the chemical and adsorptive relations implied. Lastly, the residual acids of respiration vary from hour to hour under ordinary circumstances.

It might be expected, therefore, that tests which are planned to determine the influence of acids or bases on growth would bring out a diversity of results.

G. A. Borowikow (Borovikov), a Russian working at the University of Odessa, used seedlings of *Helianthus* 6 days old for testing the effects of acids and salts upon growth.<sup>2</sup> The roots of the seedlings were immersed in water and solutions in glass jars and the effects upon growth derived from measurements of the length of the plantlets. Acceleration and final maxima were obtained by the use of hydrochloric, sulphuric, nitric, acetic, and boric acids, in the order named, that of hydrochloric being the greatest as compared with the growth of plants in distilled water. It was also noted that the addition of salts to the acids influenced the rate and final effect, according to the character of the base. Salts with weak, easily hydrolyzable bases affected growth almost solely according to the concentration of the hydrogen ions, but the stronger bases exercised a definite effect, which in this author's work was to retard growth. It is clear that the growing cell-masses of *Helianthus* are not identical in their action with such amphoteric colloids as gelatine.

Sections of growing internodes of *Helianthus* in my own work did not show their greatest swelling in simple acid solutions, but in those to which some salt of the same molecular concentration had been added. It was also found that the hydration capacity of artificially mixed biocolloids, dried and living sections of plants showed a decrease in hydration capacity with rise in temperature above 16° to 18° C. in acid solutions. On the other hand, it has been shown that in the petiole of the calla (*Richardia*), which attains a length of over half a meter and continues to elongate at varying rates throughout its entire length, the greatest acidity is in the region of most rapid growth. It is evident that interpretations must take into account a wider

<sup>1</sup> Mathews, A. P. *Physiol. Chem.*, 2d ed., p. 235. 1916.

<sup>2</sup> Borowikow, G. A. Ueber die Ursachen des Wachstums der Pflanzen. *Biochem. Zeitschr.*, 48: 230, and 50: 119. 1913.

range of conditions than those presented by the swelling of simple gelatine in electrolytes, especially at uncontrolled or unrecorded temperatures.

Professor F. E. Lloyd, working under the equable temperature conditions of the Coastal Laboratory at Carmel, California, measured the growth of pollen-tubes of *Phaseolus odoratus* in acids (hydrochloric, acetic, malic, citric, formic, and oxalic) at concentrations N/200 to N/25,600 in association with cane sugar in concentration of 40 per cent. In these solutions no growth occurs at concentrations at or above N/3,200 of the acid component. Below that limit the rate of growth is inversely as the concentration. The rate and total amount of growth possible for any concentration varied with the acid, it being least at the higher concentrations for formic and oxalic and highest for acetic.<sup>1</sup>

No temperature records are cited in any of these cases or in the other work described by Long or Dachnowski.

The measurements of E. R. Long brought out the fact that growth in *Opuntia* was greater in culture salt solutions than in any other medium tested, while that in alkaline solution was more than in either malic or hydrochloric acid, these substances being used in concentrations of N/50, while the solutions of Borowikow were N/100 or weaker.<sup>2</sup>

A. Dachnowski measured the swelling and water-relations of seeds of beans and corn and cuttings of tomato shoots and obtained some facts of great interest.<sup>3</sup> Beans were found to absorb and retain less water in acid solutions (N/800) than in equi-normal alkaline solutions. The cations Ca and Na were more active than potassium in limiting imbibition in beans, a relation which is reversed in corn grains, in which the greatest swelling took place in calcium, a lesser amount in potassium, and a minimum in sodium. Cuttings of tomato plants were found to function better in an alkaline medium than an acid, and best of all in water in absorption and transpiration. Sulphuric acid at N/3,200 and potassium hydroxid at N/6,400 furnished exceptions to these conclusions. The effect of any salt on the water-relations of the plants used was the sum of the constituent ions, a conclusion confirming the work of Borowikow.

The well-known cultural conditions required by many bacteria and fungi furnish still further exemplification of the diversity of behavior of the biocolloids in the hydration necessary for growth. The plasma of bacteria is high in albumin and many bacteria show the highest velocity and greatest development in a medium containing the soluble proteins combined with sodium chloride and brought to an alkaline

<sup>1</sup> Lloyd, F. E. Colloidal phenomena in the protoplasm of pollen tubes. Rept. Dept. Bot. Res., Year Book Carnegie Inst. Wash., 1917, p. 63.

<sup>2</sup> Long, E. R. Growth and colloid hydration in cacti. Bot. Gazette, 59: 491. 1915.

<sup>3</sup> Dachnowski, A. The effects of acid and alkaline solutions upon the water-relations and the metabolism of plants. Amer. Jour. Bot., 1: 412-439. 1914.

condition with sodium bicarbonate. The sodium albuminates which would be formed in the medium are highly dissociated, as would be the biocolloids of the cell, and both diffusion and hydration would be accelerated. This supposition would be based on the inference that the amphoteric cell-proteins were stronger acids than bases. A further result of the conditions of bacterial action is to be seen in the fact that the growth of bacteria in cultures containing carbohydrates is accompanied by the production of an acidity which checks their growth and retards their action upon proteinaceous substances present. On the other hand, many molds grow best in relatively high concentrations of acids, the cycle of fermentations in milk furnishing a striking example of the differential action of these organisms.<sup>1</sup> The first stage is characterized by the action of the lactic-acid-producing bacteria, which continue until their products reach an inhibitory concentration. The soured milk now becomes a suitable medium for *Oidium* and *Penicillium*, which may thrive in a solution containing as much as 1.25 per cent lactic acid, and continue to grow until the acid is exhausted, and then the neutral or alkaline solution again becomes a suitable habitat for bacteria.

---

<sup>1</sup>Berman, N., and L. F. Rettger. The influence of carbohydrate on the nitrogen metabolism of bacteria. *Jour. of Bacter.*, 3: 389. 1918.



## V. THE EFFECTS OF ORGANIC ACIDS AND THEIR AMINO COMPOUNDS ON HYDRATION AND GROWTH.

The biocolloids of the plant are pentosan-protein mixtures in which the substances of these two main groups vary widely in their proportions, with a smaller proportion of lipins probably more or less localized. The variables are so large that generalizations concerning the action of the plasmatic mass are not easily to be founded. Of the more important assertions concerning the action of protoplasm, the earliest and most widely used, that protoplasm undergoes hydration like an amphoteric colloid, and is exemplified by swelling gelatine, has long since failed to satisfy the experimental conditions or to offer parallels to the action of cell-masses of the higher plants.

It obviously follows that the assumption adopted by many writers that any conditions which facilitate the ionization of the proteins accelerate growth is not tenable, since the effect of acidity is to lessen hydration of the pentosans or pentosan mixtures or cell-masses when acting directly or in the presence of salts. The extensive use of agar to represent the pentosan element in biocolloids in my experiments does not imply that this substance or any other body presenting all of its main physical characters are invariably present in the cell. The gums from acacia, tragacanth, *Opuntia*, and from *Prosopis* and the cherry-tree in all probability represent types of pentosans which may really be the most abundant in plants. These gums or mucilages are readily dispersible and have an indefinite hydration capacity which soon passes beyond the limits of measurement by the auxograph. Their water-absorbing capacity would be none the less important, when inclosed in the cell-sacs. The solubility of protoplasm has formed the subject of some discussion among cytologists, and it would seem highly probable that valid observations of both extremes may have been made, the matter depending chiefly on the nature of the pentosan, gum, or mucilage which entered into the plasmatic colloids, together with the character of the more liquid phase, or the cell-sap.

The conclusions of Loeb<sup>1</sup> to the effect that it is not possible for an amphoteric colloid to be acted upon by both ions at the same time, if correct, would add still further proof to the fact that protoplasm does not behave like an amphoteric colloid in its hydration relations, except in so far as it may be predominantly composed of such material.

Data for a critical review of this matter are not available at present, but it is known that bacteria are high in albumin, and similar richness of proteins is exhibited by fungi, and that certain algæ show a large proportion of amino-acids. In addition, proteins are abundant in

<sup>1</sup>Loeb, J. Amphoteric colloids. Chemical influence of the hydrogen-ion concentration. Jour. Gen. Physiol., 1:39. 1918.

reproductive elements, while voluminous notices of these substance and their derivatives are found in cytological literature, many of which, however, need verification and analysis to make them of value.

If protoplasm were entirely or dominantly proteinaceous, the actual acidity or hydrogen-ion concentration of the sap might be taken as the chief factor in maintaining the rate and determining the course of hydration and growth. The predominance of the pentosans in plant cells, however, offers a set of conditions much more complex than that of the comparatively simple ionization of gelatine, for, as has been noted, the conditions which facilitate the action of protein gels retard and limit the hydration of the carbohydrate gels to an extent and in a manner which depend upon the structure and character of the pentosans present.

It has already been shown that pentosan colloids show maximum hydration capacity in the presence and under the action of certain amino-compounds, a subject to which the larger part of this chapter will be given.

The actual acidity, or hydrogen-ion concentration of the sap, is widely different from the total amount of acid, as some is always combined with such bases as potassium, sodium, calcium, magnesium, iron, and aluminium, making a "buffer" by which the degree of dissociation is controlled within certain limits. This range of variation as it appears in separate estimations is rather large as compared with variations in animals. It is necessary to bear in mind, however, that a cell-mass is not uniformly acid or that the entire mass of the cell-colloids is saturated with a solution of the same concentration.

In any buffer situation, however, a lessening of the hydrogen-ion concentration of the sap would be followed by increased dissociation of the acid radicle of the salts, and increase of acidity beyond a certain point would result in a reversal of the process. The actual acidity is expressed by the negative common logarithm of the number of dissociated hydrogen ions given as the value of Sorensen's symbol pH. This may vary from 3.9 to 5.7 in various succulents examined by Jenny Hempel, and may approach neutrality at pH-7 in some cases. A singular instance of wide difference between actual and total acidity is offered by lemon fruits, the sap of which has an actual acidity of pH = 2.3, which is about one-tenth the total acidity, which may be expressed as about 0.05 to 0.06 N.<sup>1</sup>

The variations in the hydrogen-ion concentration of the cell-sap and the determination of the agencies which may cause such changes offer a most inviting field for research.<sup>2</sup> In a recent paper, R. B. Harvey has described some extremely interesting changes in the as determined by potentiometer methods, of cabbage leaves in acidity,

<sup>1</sup> Hempel, Jenny. Buffer processes in the metabolism of succulent plants. *Compt. Rend. d. trav. d. Lab. Carlsberg*, 13: No. 1. 1917.

<sup>2</sup> Haas, A. R. The reaction of plant protoplasm. *Bot. Gasette*, 63: 232. 1917.

freezing, and finds that the principal effect is an increase in the hydrogen-ion concentration followed by a general return to original values on thawing, with changes in the proteins generally consisting in precipitations of some of the proteins.<sup>1</sup>

The results of Borowikow and those of Dachnowski show that the growth of the higher green plants, does not depend upon the hydrogen-ion concentration alone. Acids and bases both influence hydration and growth. In addition the accelerating effects of amino-acids and amines on hydration of biocolloids and cell-masses, living and dead, go far to support the conclusion that these substances facilitate or increase total growth. These substances are built up from simpler substances in the plant in a manner which is by no means clear, although under investigation and discussion for a quarter of a century. The evidence favors the assumption that they come together in the field of photosynthetic activity. The structure of these amino-groups may be no means be assumed to be identical with that of the amino-acids of animal metabolism, in which they occur only as disintegration products of the proteins or albumins.

The total amount of amino-compounds in a cell-mass of a plant varies widely during the course of a day, and, as has been noted above, the proportion of nitrogenous material in the organs of the cell or the members of a shoot may be greatly different.

As the hydrogen-ion concentration of the sap is known to remain fairly constant, as the salts or bases which affect growth also change but slowly, attention naturally focuses on the amino-compounds as a cause in modifying the rate, course, and total amount of growth. As the acids and their salts may be assumed to act invariably in the presence of amino-groups, a series of tests were planned which should make possible a comparison of the action of some of the commoner organic acids and their amino-compounds.

Two groups were chosen for the tests—succinic acid and its amino-compound, amino-succinic or aspartic acid, which are dibasic; and its amide, as noted above, which is monobasic; and acetic acid and its amino-compound, glycocoll, which are monobasic. Sections of plates of agar, gelatine, agar-gelatine, agar-protein, and other mixtures were used. Swellings were carried out in the equable chambers of the Coastal Laboratory, at 15° to 16° C. The principal results are given in table 45.

The two organic acids, succinic and acetic, are seen to exert the classical effect on gelatine, the greatest hydration taking place in the higher concentrations, the effect decreasing with dilution until at 0.0004 N the swelling in acetic acid was scarcely greater than in distilled water. At 0.0004 M, however, the dibasic succinic acid showed

<sup>1</sup> Harvey, R. B. Hardening processes in plants and developments from frost injury. *Jour. Agric. Res.*, 15: 83. 1918.

a swelling less than that in distilled water, a result that suggests a rapid solution or dispersion from the surfaces of the sections and alterations of viscosity in the mass.

TABLE 45.—Hydration of agar, gelatine, agar-gelatine, and agar-oat protein in organic acids and their amino-compounds at 16° to 17° C. Expansion in percentages of dried thickness.

	Concentration. Mol.	Succinic acid.	Aspartic acid.	Aspar- agine.	Acetic acid.	Glyco- coll.
		<i>p. ct.</i>	<i>p. ct.</i>	<i>p. ct.</i>	<i>p. ct.</i>	<i>p. ct.</i>
AGAR.	0.3	.....	.....	.....	.....	1,950
	.5	.....	.....	.....	1,060	2,804
	.1	.....	1,000	2,260	1,333	.....
	.05	1,091	827	2,308	1,433	.....
	.01	1,273	1,270	2,365	1,560	2,965
	.002	1,600	1,400	2,440	1,790	3,166
	.0004	1,750	1,788	2,720	1,955	2,605
	.00008	2,528	2,080	3,250	2,640	.....
Water, aver. 2,600 per cent.						
GELATINE.	0.1	.....	.....	.....	.....	.....
	.05	1,200	1,500	320	952	370
	.01	700	1,033	480	714	.....
	.002	500	380	500	690	360
	.0004	433	340	467	643	360
Water, aver. 600 per cent.						
AGAR 8 PARTS, GELATINE 2 PARTS.	0.5	.....	.....	.....	.....	.....
	.1	.....	.....	.....	850	.....
	.05	716	910	1,485	850	1,233
	.01	850	1,017	1,674	900	1,960
	.002	917	1,295	1,608	922	1,767
	.0004	1,000	1,667	1,383	1,117	1,420
	.00008	1,030	1,788	1,383	1,167	1,484
Water, aver. 1,684 per cent.						
AGAR 8 PARTS, OAT-PROTEIN PARTS.	0.5	.....	.....	.....	500	.....
	.1	.....	.....	.....	809	.....
	.05	700	855	1,867	1,090	1,983
	.01	864	900	2,455	1,255	2,340
	.002	909	1,670	2,523	1,738	3,050
	.0004	1,136	2,600	2,675	2,238	3,000
	.00008	2,330	3,050	2,600	2,480	.....
Water, aver. 2,365 per cent.						

Mixtures of agar (8 parts) and gelatine (2 parts) were now tested, and the hydration in succinic acid at 0.00008 M was but 1,030 per cent, as compared with 1,684 per cent in water, while acetic acid was slightly higher, 1,167 per cent. A similar statement would hold for the action of these acids on agar and for agar-protein, the hydration in water alone being reached more nearly than in the agar-gelatine sections.

When we now turn to amino-succinic or aspartic acid and amino-acetic acid or glycoll, some new relations are uncovered. The aspartic acid appeared to exercise a notable influence on the hydration of agar. The limit of its solubility appeared to be about 0.05 M at 15° to 20° C. When more than this was added to the water

used for solution a swelling in excess of the expectancy resulted. It was also seen that the surface of the liquid became covered with thin crystals. In all probability the solution or dispersion of some agar into the water resulted in the displacement of some of the acid, with the result that the sections were actually hydrated from a solution less concentrated, giving a swelling in excess of the expectancy.

Tests were now made at the same temperature and under the same conditions with plates consisting of agar (8 parts) and gelatine (2 parts), in order to ascertain the results when the carbohydrate was in colloidal combination with complex amino-compounds. The trios of sections had shown swellings of about 1,700 per cent in distilled water under the same conditions and had an average thickness of 0.28 mm.

TABLE 46.

	<i>p. ct.</i>
Aspartic acid, 0.05 M.....	910
Aspartic acid, 0.0002 M.....	1,090
Aspartic acid, 0.00008 M.....	1,786

The effect of the acid is seen to vanish at a much greater concentration than on the agar alone, the swelling at saturation being about half that of distilled water.

After the experience noted above, new plates of agar (9 parts) and aspartic acid (1 part) were made. The amino-acid was placed in the water in which the agar was liquefied to a 2.5 per cent solution. The usual translucency of the agar was modified to a pale milky appearance, and its viscosity seemed to be decreased. Soon after setting, cracks and fractures appeared in the plates. This of course allowed shrinkage in the long axes of the plates and would make it impossible for the sections to swell in thickness to the same proportion as the coherent agar plates. These new plates came down to a thickness of about 0.16 mm. and showed swellings of 220 per cent in distilled water at 16° C. and of a slightly greater expansion in a solution of 0.05 M asparagin, in which the swelling was 281 per cent. It is to be noted that while the aspartic acid is present in a more concentrated condition in these plates than is possible in water, yet the entire amount was held in the colloidal mesh or plate and showed no formation of crystals on the surface or in the sections, as in the case of the less-soluble tyrosin. The hydration of the colloid with the acid incorporated in it is less than that which may take place when the acid is dissolved to saturation in the water in which the swellings are made. The influence of this acid on agar was not widely different from that of succinic acid, but it caused greater swelling in equimolecular concentrations in gelatine, agar-gelatine, and agar-protein.

The amine of this group was now tested both in solution and incorporated in agar sections. Plates of agar (9 parts) and asparagine (1 part) were prepared and swelled in comparison with aspartic acid, giving results shown in table 47.

TABLE 47.—16° to 18° C.

	Water.	Citric acid, 0.01 N.	Sodium hydroxid, 0.01 M.
	<i>p. ct.</i>	<i>p. ct.</i>	<i>p. ct.</i>
Agar 9, asparagine 1.....	640	300	402
Agar 9, aspartic acid 1....	296	250	625

The proportion of the acid and the asparagine being too high to be of any physiological interest, new plates with half the quantity of acid and amine were prepared, and these came down to a thickness of 0.32 and 0.33 mm., which swelled 1,875 per cent in distilled water as compared with agar, which showed a hydration capacity of 2,700 per cent. The effect in this trial was not so marked as in the first series, but it is evident that the incorporation of the asparagine in any proportion in the colloid affects hydration to a greater extent than the perfusion of the asparagin in the same concentration, which in this case gave swellings of 2,300 per cent. Even a 0.1 M solution with double the amount present in the solution did not reduce the hydration to the limits shown by the agar-asparagine plate used in this test. The asparagine was present in such amount that if diffused out of the sections it would have made a 0.04 M solution in the 30 c.c. of water in the dish.

Asparagine was now applied in a series of concentrations to sections of agar of the above swelling capacity in water and it was found that hydration was actually increased or accelerated by the presence of the amine. That this result did not simply appear by faulty comparisons was shown by the following replacement test:

A trio of sections which had been swelled in distilled water to a total of 2,630 per cent, and which had stood in the solution without any perceptible change for a few hours after the close of the test, was now treated with a 0.01 M asparagine solution. The mechanical disturbance which might result from changing the liquid in the dishes was minimized by fractionization. About one-third of the water was removed, the level was raised by the addition of asparagine solution, and this was repeated about a half-dozen times, the final result being a solution which was diluted slightly below the hundredth normal. A slow expansion began at once, which continued for about 20 hours, which raised the total hydration of these sections to 2,890 per cent, an increase of 230 per cent, due to the action of the asparagine on sections which had undoubtedly been reduced in mass somewhat by solution from the surfaces.

When asparagine is applied to mixtures in which the gelatine is replaced by an albumin, the results included some special reactions. Plates of agar and oat-protein were made up to contain 8 parts of the

first and 2 of the last, coming down to a thickness of 0.22 to 0.23 mm. These swelled at 17° C. to the proportions shown in table 45, which in some cases exceeded that in water. The swelling in concentrations as high as 0.01 M were but little below that in water.

Glycocoll has been used in many cultural tests with plants and various interpretations have been placed on its accelerative influence on growth. The experiments with this material, therefore, included the possibilities of the manner and extent to which this might accompany or run parallel with hydration reactions.

The first trials were made with this reagent incorporated with liquid agar in such proportion that the amount present in three sections would have been equivalent to that in 30 c.c. of 0.14 M solution. Trios of such sections 0.15 mm. thick gave swellings of 1,133, 1,267 and 1,300 per cent in water at 16° C., which is much less than that shown in a solution at 0.3 M containing twice as much of the amino-acid. (Table 45).

Thin sections of agar swelled in all glycocoll solutions less concentrated than 0.3 M to the amplitude attained in water and exceeded it in some cases, a fact which for the first time gives a sound basis for cultural tests in which growth was accelerated and the total increased by this compound.

Another pentosan, gum tragacanth, was dried from solutions to form sections 0.13 mm. thick on filter-paper. Swellings at 15° C. were obtained, as shown in table 48.

TABLE 48.		<i>p. ct.</i>
Distilled water.....		1,380
Glycocoll, 0.03 M.....		1,382
Glycocoll, 0.05 M.....		1,077
Glycocoll, 0.01 M.....		1,462

This gum liquefies irregularly, and hence the figures show the extent of swelling before active dispersion of the mass begins.

A mixture of 9 parts gelatine and 1 part gum tragacanth was made up at 25 per cent to correspond to a similar mixture of gelatine and opuntia mucilage. Swellings as follows at 15° C. were obtained:

TABLE 49.		<i>p. ct.</i>
Distilled water.....		1,320
Glycocoll, 3 M.....		1,520
Glycocoll, 0.05 M.....		1,040
Glycocoll, 0.01 M.....		1,320

Nothing may be concluded on the basis of these figures, except that the hydration of this material reaches a stage where it goes into dispersion unevenly and in a manner which makes auxographic readings, as well as all mass or weight determination, of doubtful value.

The above tests were repeated with opuntia mucilage at 15° C., with results as shown in table 50.

TABLE 50.		<i>p. ct.</i>
Distilled water.....		923
Glycocoll 3 M.....		800
Glycocoll 0.05 M.....		654
Glycocoll 0.01 M.....		600

Here again the uneven dispersion of the mucilage results in auxographic records, the obvious meaning of which would be unsafe to follow. It is highly probable that the high relative swelling in the concentrated solution is due to coagulatory or aggregation effects, especially on the surfaces of the sections, resulting in a sac-like condition which would show considerable increase before dispersion began, resulting in a final shrinkage. This dispersion began earlier in the weaker solutions.

Swellings of gelatine in glycocoll ran uniformly low, the presence of this substance apparently accelerating solution of the gel.

Sections consisting of 4 parts agar and 1 of gelatine which had an average thickness of 0.3 mm. swelled as follows at 15° C. in glycocoll:

TABLE 51.		<i>p. ct.</i>
Glycocoll, 0.3 M.....		1,550
Glycocoll, 0.05 M.....		1,233
Glycocoll, 0.01 M.....		1,960
Glycocoll, 0.002 M.....		1,767

The average swelling of such sections in water was about 1,700 per cent and the irregularity characteristic of auxographic measurements of the action of this amino-acid is seen in the above results.

A preparation was now made in which 2 parts of the water-soluble protein from oats was added to 8 parts of agar in a 2.5 per cent solution of the latter. The plates dried to a thickness of 0.25 mm. When sections of such biocolloids were swelled in the glycocoll series, the results were as shown in table 45, the hydration in concentrations less than 0.01 M approaching and surpassing those in distilled water.

A number of tests were made to determine the influence of glycocoll on hydrations in acetic acid. The first was that of surface slices of *Opuntia*, which had dried to a thickness of 0.8 mm. Trios swelled 163 per cent in 0.05 N acetic acid and 156 per cent in a 0.05 N solution of acetic acid and glycocoll each. No especial significance can be attached to the lesser swelling in the double solution, except that no evidence as to acceleration of swelling by the addition of the amino-acid was obtained.

Next, trios of sections of 8 parts agar and 2 parts gelatine 0.3 mm. in thickness were swelled in the acetic and amino-acetic solutions 0.01 N at 18° C. The swelling in the acetic acid alone was 1,450 per cent, while that in the combined solutions was but 1,300 per cent, which agreed with the previous effects in being less than in the acid alone. It is to be noted that the amount of the acetic acid in the combined solution in the swelling-dish would be but half that when this acid was used alone.



Trios of sections of agar swelled 1,875 per cent in a 0.01 N solution of acetic acid at 18° C., while a combined solution of equivalent molecular concentration showed a swelling of 1,750 per cent.

There now remained the test with living tissues. Some joints of *Opuntia blakeana* of 1918, which had been brought from Tucson two months earlier and had laid on the table, with the result that they had lost much water but were still alive, were used for this test. A trio of sections with an average thickness of 6 mm. swelled 60 per cent in the hundredth-normal acetic acid, while a similar trio which measured 5.5 mm. on the average swelled but 45.5 per cent in the combined acetic-glycocoll solution. A second feature distinguished the two reactions, the swelling in the acetic acid being continuous and approaching zero during the 20 hours of measurement, while in the combined solution full expansion was reached in 4 hours, after which a shrinkage resulted in a loss of nearly 5 per cent, suggesting that the H-ion concentration of the combined solution was greater than that of the acid alone.

A return was made to the biocolloidal mixtures and trios of sections of agar 8 parts and oat protein 2 parts, with a thickness of 0.22 mm., swelled at 18° C. The hydration in the hundredth-normal acetic acid gave an increase of 1,318 per cent, while an equimolecular solution of the acetic acid and glycocoll gave a swelling of 1,605 per cent. This test is the only one of the series in which the addition of glycocoll to the acetic acid enhances imbibition. In this last test the amount of solution poured in each dish was such that the same quantity of the acetic acid was present in both.

An additional test was made in which equal amounts of glycocoll and acetic acid were brought together at a concentration of 0.001 M each on agar-oat protein sections as above. The swelling in the acetic acid was 2,681 per cent, or about the same of that possible in distilled water (2,630 per cent), while the swelling in the combined solution was slightly less, being 2,570 per cent.

Glycocoll and other amino-groups are present in the plant in comparatively great dilutions, and probably at no time does the amount present reach the concentration in which a retardation or limiting of the hydration effect would be exerted. The experiments described show that glycocoll and asparagin may actually increase the hydration capacity of pentosan and of pentosan-protein colloids. The meager results obtained from swelling plant-sections are not harmonious and further experimentation is highly desirable. The accelerating effect of glycocoll is a subject which has come up for notice many times. Dakin connected its action with possible catalytic effects.<sup>1</sup> The similarity of the results obtained from agar and agar-protein mixtures

<sup>1</sup>Dakin, H. D. The catalytic action of amino-acids, etc., in effecting certain syntheses. *Jour. Biol. Chem.*, 7: 49-55. 1909.

and from the swelling of plants makes it fairly certain that the effect is due primarily to the action of the pentosans.

The most recent tests of the effects of glycocoll on plants are those of Borowikow,<sup>1</sup> completed in 1913 and published in the same year, and those of Dachnowski, brought out in 1914.<sup>2</sup> Borowikow took the position that substances which facilitate hydration of the plasmatic colloids accelerate growth, and that such hydration was one of proteins, an assumption which is not sound. His trials consisted in comparing the growth of seedlings of *Helianthus* in distilled water as a check or control with the substances to be tested added to water, the measurements being taken during a few hours only. Glycocoll was used in 0.01 N and 0.005 N concentration. Such concentrations are relatively high for the plant, and only retardation effects were obtained.

Dachnowski's figures indicate that glycocoll added to hydrochloric acid in concentrations of N/1,600 (50 c.c. N/800 of each substance) causes an increase in the amount of water absorbed by bean seeds, and a lesser increase of hydration in corn seeds.

Both absorption and transpiration by cuttings of tomato were less in solutions of hydrochloric acid ranging from N/800 to N/6,400 than in water, but this retarding effect was counteracted to some extent when glycocoll was added to the solutions. This amino-acid also caused an increased gain in weight in acid and alkaline solutions.

The hydration phenomena described in the preceding pages afford some interesting parallelisms with the action of these compounds on growth, absorption, and transpiration.

It is evident that we must definitely and finally cease to treat a plant cell-mass as an amphoteric colloid with a dissociation expressed by the actual acidity of the cell-sap. Such dissociation and resultant hydration capacity may determine the action of protoplasts or of cell-organs which are chiefly proteinaceous.

Vegetative cell-masses such as are responsible for growth, and the activity of which constitutes growth in the larger sense, are composed of colloids predominantly of a carbohydrate character. These pentosans do not dissociate. Their swelling capacity in electrolytes is less than in pure water. The hydration of agar and the pentosans in acids is retarded or lessened by the action of H ions, so directly that the proportionate swelling of agar in an acid such as acetic or succinic might be used as a measure of the concentration of the acid solution (see p. 57). This fact and the part played by the dissociation of gelatine may be traced through all of the results on hydration of agar, agar-gelatine, and agar-protein mixtures. Thus, for example, agar

<sup>1</sup>Borowikow, G. A. Ueber die Ursachen des Wachstums der Pflanzen. *Biochem. Zeitschrift*, 50: 119. 1913.

<sup>2</sup>Dachnowski, A. The effects of acid and alkaline solutions upon the water-relations and the metabolism of plants. *Amer. Jour. of Bot.*, 1: 412-439. 1914; also, Dachnowski and Gormley. The physiological water requirement and the growth of plants in glycocoll solutions. *Amer. Jour. of Bot.*, 1: 174-185. 1914.

alone gives an average swelling of about 2,600 per cent of plates 0.18 to 0.20 mm. in thickness at 13° C. When combined with gelatine in proportions of 8 to 2, the swelling is less than 1,700 per cent.

The reactions of the pentosans and pentosan-protein colloids in solutions of the amino-compounds show some highly important departures, the chief of which is the fact that the hydration capacity is greater than in distilled water in such monobasic acids, but not in the dibasic aspartic acid. This last-named substance dissociates, so that .01 M, pH=3, in accordance with which it is found to lessen the hydration capacity of agar, but, on the other hand, this action is not shown by the pentosan-protein mixture. No explanation may be offered for this behavior and for the excessive swelling of pentosans and pentosan mixtures in amino-compounds, except that amino-compounds may form salts with the carbohydrate, thus increasing the hydration capacity of the latter. That this superior swelling is an actuality is well demonstrated by the increase that resulted when agar-albumin sections in a condition approaching complete hydration showed a further marked increase when the water was replaced with an asparagin solution. The positive action of the amino-compounds is also well demonstrated by the fact that the maximum effects were produced at a concentration not coincident with the maximum concentration and at a point of great dilution.<sup>1</sup>

When these results are applied to the conditions in the cell, emphasis is given to the fact that the total of amino-acids is always no more than a fraction of the amount of organic acids present. It is highly probable that these substances, originating constructively in the plant and affecting growth in a profound manner, may do so partly by their participation in the buffer processes.

---

<sup>1</sup> MacDougal and Spoehr. The effect of organic acids and their amino-compounds on the hydration of agar and on a biocolloid. *Proc. Soc. Exper. Biol. and Med.*, 16: 33. 1918.

## VI. REACTIONS OF BIOCOLLOIDS AND CELL-MASSES TO CULTURE SOLUTIONS, BOG, SWAMP, AND GROUND WATER, AND OTHER SOLUTIONS.

The organism encounters a variety of substances in solution in the substratum or medium to which, of course, the colloids of the cell react in a manner determined by their own composition and that of the impinging substances. The surest knowledge of the complex relations involved will in the end rest upon results obtained by analytical experiments in which the effects of separate substances and graded concentrations of the elements are first determined and then their action in combination is measured. Meanwhile, a number of standard or commonly accepted solutions are used for a variety of cultural and experimental purposes and an effort was made to ascertain the reactions of biocolloids and of sections of plants to them in terms of imbibitional swelling. The idea was extended to include the "natural waters" which are characteristic of some well-defined plant habitats, such as bogs and swamps.

A large and important share of the knowledge of the physiology of plants rests upon cultures made with "nutrient solutions." One of these, after a formula devised by W. E. Tottingham, was chosen for the test.<sup>1</sup> Its composition was: potassium nitrate 4.048 g., dipotassium phosphate 12.980 g., magnesium sulphate crystals 29.280 g., and calcium nitrate 27.920 g., in 4,000 c.c. of water. A precipitate comes down in the bottle on standing. This was filtered out and dissolved in distilled water, which was used to dilute the solution to a concentration of about 0.5 per cent total concentration.

The preliminary trial of the effect of the whole solution was made with sections of a plate consisting of 95 parts agar and 5 parts of bean protein, an old preparation which had been exposed to the damp air for a month. The swelling measurements were as follows:

TABLE 52.

	<i>p. ct.</i>
Water.....	617.6
Nutrient solution, 0.5 p. ct.....	500
Citric acid, 0.01 N.....	406.8
Sodium hydroxid, 0.01 M.....	431.4

The only feature of interest in the results was the low imbibition in water, the dried sheet being an old one. A fresh preparation was made with the agar and bean protein in the same proportion as before, and a double series of instruments was used in the test.

In order to determine the possible interference or antagonism of the four constituents, tests were also made of the separate action of the four

<sup>1</sup> Tottingham, W. E. A quantitative chemical and physiological study of nutrient solutions for plant cultures. *Physiol. Res.*, 1: No. 4. May 1914.

salts in the concentrations in which they occur in the culture solution (table 53).

The total amount of swelling in the culture solution is scarcely more than half that in distilled water, that in the dipotassic phosphate not falling much below that of water. Swelling in potassium nitrate is much greater than that shown in the culture solution. The low imbibition in calcium nitrate is in accordance with the expectancies.

TABLE 53.

	Dist. water.	Nutrient soln., 0.5 per ct.	Potass. nitrate, M 0.00285.	Magn. sulphate, M 0.00898.	Calc. nitrate, M 0.00844.	Di-potass. phosphate, M 0.00681.
Swelling in 10 hours....	<i>p. ct.</i> 1,360 1,300	<i>p. ct.</i> 720 760	<i>p. ct.</i> 1,040 900	<i>p. ct.</i> 740 740	<i>p. ct.</i> 340 600	<i>p. ct.</i> 1,200 940
Average.....	1,330	750	970	740	470	1,070
Swelling in 24 hours....	1,560 .....	800 .....	1,260 .....	804 800	680 500	1,400 1,300
Average.....	1,560	800	1,260	802	590	1,350

The magnesium salt exercises an imbibitional action equivalent to that of the complete solution. The potassium salts allow a notably greater swelling. Apparently the calcium salt interferes, or exercises an antagonism which results in the averaged total exemplified. The actual relative action of these salts, however, can not be taken up at this time. A consideration of the imbibitional action of the constituent salts might yield some data which would be of value in determining the composition of culture solutions for special purposes.

A similar series of tests of the effect of the nutrient solution and its components upon growing tissues were made with sections of young stems of *Rudbeckia* bearing young flower-heads. Tangential slices were removed from one side to allow expansion and trios of pieces a centimeter long and 3.5 mm. in thickness were placed under the auxographs in a dark room at

16° C. Air-dried sections of the same stems which had been exposed to the air and light for a day and had shrunk to about half of their original thickness were now placed in identical solutions. The swellings of the fresh and of the dried sections are given in table 54.

TABLE 54.

	Living sections.	Dried sections.
	<i>p. ct.</i>	<i>p. ct.</i>
Water.....	5.8	28.6
Nutrient solution.....	4	15.7
Potassium nitrate.....	4.3	27.1
Magn. sulphate.....	2.8	20
Calcium nitrate.....	2	3.6
Di-potassium phosphate..	2.9	12.8

Several variations are apparent, but perhaps the relations of greatest importance are those which may be expressed by saying that the imbibition of dried specimens is five times that of living material in distilled water, only four times in nutrient solution, over six times in potassium nitrate, over seven times in magnesium sulphate, less than twice in calcium nitrate, and over four times in dipotassium phosphate. It is to be noted that when a section of living tissue is dehydrated it is not possible to restore the cell-colloids to their original condition simply by swelling. This is due chiefly to the fact that, as desiccation proceeds, the salts, acids, sugars, etc., in the liquids are concentrated until finally they are fixed by the solidifying protoplasmic gel in this condition. Rehydration must then take place as in a salted colloid with the sugars in a concentration in which they may modify imbibition.

Petioles of young leaves of *Phytolacca*, with a thickness of 3 mm., swelled 4.2 per cent in distilled water and an equal amount in potassium phosphate, 5 per cent in magnesium sulphate, 3.3 per cent in calcium nitrate, and 2.5 per cent in the nutrient solution. The equivalence or uniformity of the material was in doubt, however, and the test was not extended to dried sections.

The 4-angled stems of *Mentha spicata* offered certain mechanical advantages, and the internodes near the apex of the stem which were half-grown and with a thickness of 3 mm. were selected. Trios of sections 3 or 4 mm. long were tested with distilled water, culture solution, and its components. The swelling of fresh specimens was very slight, varying from 0.05 to 0.1 mm., and no safe comparisons could be made. Dried sections came down nearly half of their original dimensions, and when a series was swelled in distilled water the increase was but 12.9 per cent and in hundredth-normal citric acid 6.4 per cent, while in hundredth-molar sodium hydroxid the increase was 19.3 per cent. These results indicate that the plant colloids were in an acidified condition, the swelling in water and in acid being consequently small, while that in alkali was a swelling in a neutralized or nearly neutralized condition. The dried series in the culture solution and its components gave swellings of 16.8 per cent in distilled water, almost no swellings in nutrient solution (due to defective wetting by the liquid), 19.3 per cent in potassium nitrate, 12.6 per cent in magnesium sulphate, 9.6 per cent in calcium nitrate, and 4.8 per cent in dipotassic phosphate. The swelling of dried sections presents some possible sources of error in the limited surfaces presented for absorption which may be "waterproofed" in some cases, while in other instances the sections collapse or do not swell toward their original form.

Direct effects of the waters of bogs and swamps in producing modifications of growth, departures in structure and form, and in influencing general nutrition are well established and have long been known.

The numerous analyses of the water have failed to disclose physico-chemical features which might be held responsible for the very direct and positive action exercised in the determination of the plant formations of such places. The history of such attempts is a long one.<sup>1</sup>

Bog water was furnished by Mr. E. R. Long, who procured a sample from Ronalds, in the region of Seattle, Washington. Dr. J. M. McGee reports the following constituents per liter:

TABLE 55.		gm.
Organic matter .....		0.106
Ash (chiefly CaSO <sub>4</sub> ) .....		.048
Total soluble residue .....		.154

Swamp water was procured by the kindness of Dr. S. A. Gortner, who obtained a sample from near Anoka, Minnesota, concerning which he says:

"This sample was taken about 20 miles north of Minneapolis, in Anoka County, of which three-fourths of the area consists of peat lands. These peat lands are of the grass and sedge formation, the peat being from 4 to 6 inches or more deep, fairly well decomposed, and one of the better grades of peat for agricultural purposes in that it contains an appreciable amount of lime. I believe that you will find this sample of water perfectly typical of most of the large grass bogs of Minnesota."

The analysis of this water shows the following per liter:

TABLE 56.		gm.
Soluble organic matter .....		0.094
Ash (CaSO <sub>4</sub> with trace of NaCl) .....		.128
Total soluble residue .....		.222

The degree of acidity of the bog water was such that 1.1 c.c. of N/10 potassium hydrate was necessary to neutralize 100 c.c. of water. The acidity of the grass-sedge water was scarcely a third of this, but 0.35 c.c. N/10 potassium hydrate being necessary to neutralize 100 c.c.

The first trial of the action of these waters and comparative solutions was made with living material. Circular disks 12 mm. across and of an average thickness of 11 to 13 mm. were cut from joints of *Opuntia discata* which had matured at Carmel, California, in the summer of 1917. Tests were made with water, swamp water, bog water, and various calcium solutions at 15° C. The measurements obtained were as follows:

TABLE 57.		p. ct.
Distilled water .....		18.2
Swamp water .....		13.6
Bog water .....		18.3
Calcium nitrate, 0.008 M .....		15.5
Calcium nitrate, 0.008 M acidified with nitric acid .....		16.8
Calcium nitrate, 2 M (shrinkage and subsequent swelling) .....		6.8
Calcium nitrate, 0.2 M (steady shrinkage) .....		.....
Calcium nitrate, 0.02 M .....		14.6
Calcium nitrate, 0.002 M .....		15.5
Calcium nitrate, 0.0002 M .....		21

<sup>1</sup> See Rigg, G. B., Summary of bog theories. *Plant World*, 19:310, 1916.

The uppermost line shows a swelling in bog water equivalent to that in distilled water, while the imbibition in swamp water is very much less, sustaining about the same proportions as the measurements of the swelling of biocolloids. The retarding action of the swamp water, high in calcium, is greater than that of the solution 0.008 M, in which this salt enters into nutrient solutions, and greater even than that of a 0.02 M solution. The retarding action of swamp water may be predicted to be about the same as a 0.03 M solution of calcium nitrate acidified as in the solution used. Such acidification was made by adding 1 c.c. of hundredth-molar nitric acid to 25 c.c. of the calcium solution.

The final cessation of shrinkage and slight enlargement of sections in the 2 M solution remains unexplained, since the shrinkage in a solution containing but one-tenth of this amount of calcium was constant during the entire 90 hours of the exposure. The final figures in 2 M to 0.0002 M are of swellings which were continued for 90 hours, while the swellings in water, swamp water, bog water, calcium as in a nutrient solution, and acidified calcium solution were taken at the close of 40 hours. The total swelling of 21 per cent in calcium nitrate 0.0002 M is probably equivalent to that of distilled water. The swellings of biocolloids in the same solutions should receive attention in this connection.<sup>1</sup>

In addition to the above note on the swelling of the sections in the 2 M solution of calcium nitrate, the following facts are of interest: Four sections with an aggregate thickness of 37 mm. were placed in a dish and covered with such a solution at the time the auxograph measurements were started. As the sections under the auxograph were in an expanding stage when the measurements were closed, free sections were allowed to remain in the dish after the records on the instrument were ended. The free sections were measured 6 days after being put in the concentrated solution, with the result that their total thickness was found to be 42 mm., a gain of 5 mm. or 13.3 per cent.

Sections of a biocolloid consisting of agar 90 parts and oat protein 10 parts were swelled in a series of solutions of calcium nitrate parallel to the above set. The increase in the 0.5 M solution was 975 per cent, 525 per cent in the 0.2 M solution, 650 per cent in the 0.02 M solution, 1,425 per cent in the 0.002 M solution, and 1,975 per cent in the 0.0002 M solution. The test was repeated with the following results at the end of 24 hours: swelling in 2 M solution, 917 per cent; in 0.2 M solution, 722 per cent; in 0.02 M solution, 777 per cent; in 0.002 M solution, 1,555 per cent.

The minimum swelling in this series evidently lies between the concentrations of 0.2 M and a molar solution.

Another series was carried out in which sections of *Opuntia* were swelled at temperatures of 18° to 20° C. in acidified and salt solutions, as given in table 58.

---

<sup>1</sup> MacDougal, D. T. The effect of bog and swamp waters on swelling in plants and in biocolloids. *Plant World*, 21:88. 1918.



TABLE 58.

Swamp water.....	p. ct.
Swamp water, citric acid, 0.01 N.....	14
Potassium nitrate, 0.01 M.....	15
Citric acid, 0.01 N.....	14
Potassium nitrate, citric acid, 0.01 N.....	7
Potassium hydroxid, 0.01 M.....	9
	12

The measurements in swamp water alone and with acid include the full increase in 96 hours, while the others extended over from 20 to 40 hours.

No important effect can be ascribed to the acidification of swamp water. The swelling of the sections in the hundredth-molar solution of potassium nitrate was but little below that in the swamp water, but when this solution was similarly and equally acidified, a decrease ensued. The foregoing tests were made with sections in a living condition, in which questions of permeability and osmotic action might possibly play a part. Material was prepared to exclude the action of the living cell. The chlorophyllous layers were removed from the two sides of joints of *Opuntia* and slices 7 mm. in thickness were cut in the plane of the joint and placed between two sheets of filter-paper, to one of which they adhered. A third sheet was laid over them and the preparation placed on a wire netting to dry without pressure. In 6 days the thickness had been reduced to about 0.5 mm. and enough moisture still remained to give the slices a leathery consistency. Suitable sections free from visible fibrovascular tissue were prepared which gave swellings as follows:

TABLE 59.

	Living sections.	Dried sections.
	p. ct.	p. ct.
Distilled water.....	660	47
Bog water.....	640	45
Swamp water.....	530	38
Culture solution, 0.5 per cent.....	625	44

The measurements were taken at the end of 24 hours, when a fair rate of increase was still noticeable which would in the end have carried the figures up to the next hundred in the dried sections. The swelling of living material in bog water is but little less than in distilled water and is also but little different from that in the culture solution, which is of the concentration used in water cultures. Hydration is, however, noticeably less in swamp water.

Attention was now turned to the biocolloids to ascertain whether the action of plant material living and dried would find a parallel in the action of mixtures of known composition. Sections of plates composed of agar (90) and oat protein (10) were found to show the following swellings at 15°C.

TABLE 60.

Distilled water.....	p. ct.
Bog water.....	2,188
Swamp water.....	2,083
	1,200

The decreased swelling in swamp water and the high swelling in bog water were marked and invariably shown.

However, the biocolloid approaches more nearly to the condition of the protoplast when, in common with all living matter, it includes some salts. The above mixture containing culture salts was not available, but some plates in which the oat protein was replaced by bean protein to which had been added 0.8 per cent of culture salts were swelled in a parallel series. The untreated mixture free from the added salts does not show as high an imbibition capacity as that made up with the oat protein. The measurements of the increase of the agar-bean protein-salted sections at 15° C. were as shown herewith:

TABLE 61.

	<i>p. ct.</i>
Distilled water.....	1,525
Bog water.....	1,525
Swamp water.....	1,100
Calcium nitrate, 0.008 M .....	825

These measurements were taken at the end of 40 hours, while some increase was still in progress, but the final relations would not have been materially altered by the use of the end-points for the comparisons. The retarding action of the swamp water and the equivalence of swelling in pure water and bog water therefore runs plainly defined through all of the experiments with living and dried sections of plants and in tests with salted and unsalted biocolloids. Calcium nitrate in the concentration used exercises a more marked effect on the salted biocolloid than on the unsalted mixture and on the plant material. The calcium content of the biocolloid is probably much higher than that of the plant, so that the two sets of measurements are not strictly comparable.

The calcium solution contained about eight times as much salt as the bog water and nearly three times as much as the swamp water, which also includes a trace of sodium chloride. A series was therefore arranged to compare the action of the two with equivalent salt solutions. Sections of agar and bean protein impregnated with 0.8 per cent of culture salts were swelled at 15° C. with results as follows:

TABLE 62.

	<i>p. ct.</i>
Distilled water.....	1,417
Bog water.....	1,444
Calcium sulphate 0.048 gram per liter.....	1,417
Swamp water.....	944
Calcium sulphate 0.128 gram per liter.....	1,083

Bog water and an equivalent calcium solution allow equal swelling, but the increase in swamp water is much less and also less than in the equivalent calcium solution, to which may be attributed most of the retarding effect of the swamp water.

The imbibition capacity of the biocolloids varies with the proportions between the carbohydrate and the proteins and protein derivatives. A biocolloid was subsequently made up which included a high nitrogen-content and a second carbohydrate and five albuminous compounds. For this purpose, 70 parts agar, 5 parts each of dextrose, peptone, gelatine, asparagin, nucleinic acid, and bean protein were suitably liquefied and poured into plates which dried down to a thickness of 0.2 mm. Swellings of sections of these plates at 15° C. gave the following increases at the end of 24 hours:

	<i>p. ct.</i>
Distilled water.....	725
Bog water.....	592
Swamp water.....	550
Calcium chloride, 0.2 M.....	350
Calcium chloride, 0.1 M.....	400

The total swelling in distilled water for this biocolloid is low, although it is to be noted that swellings as high as 1,200 per cent in distilled water have been measured at temperatures of 18° to 20° C.

Sections from plates made up as above, but to which had been added 0.8 per cent of culture salts, gave increases as follows at temperatures of 15° C.:

	<i>p. ct.</i>
Distilled water.....	600
Bog water.....	525
Swamp water.....	625

This complex biocolloid, high in nitrogen and in the culture salts, displays hydration capacity in swamp water superior to that shown in bog water or pure water. The properties in question would enable a plant so equipped to thrive in the waters of swamps, and it would be interesting to determine whether such a condition actually prevails in the plants of the sedgy swamps.<sup>1</sup>

The earlier attempts to interpret the swelling action of protoplasm were founded on the assumption that such increase might be represented by the action of gelatine. The unsoundness of this assumption and the inadequacy of the methods using this material have been amply demonstrated by results previously published. At one end of the scale stand some plants and some plant structures high in proteinaceous compounds and low in pentosans, and these do show a behavior approximating that of gelatine. This is illustrated by the following series, in which sections of gelatine plates 0.18 mm. in thickness were swelled at 15° C., giving measurements as follows:

	<i>p. ct.</i>
Distilled water.....	778
Bog water.....	889
Swamp water.....	939
Culture solution, 0.5 per cent.....	889
Potassium nitrate, 0.01 M.....	911

<sup>1</sup> Schimper, A. F. W. *Die Indo-Malayscher Strandflora*, p. 142. 1891.

The swelling of sections of agar plates 0.2 mm. in thickness at 15° C. resulted in increases of:

TABLE 66.

	<i>p. ct.</i>
Distilled water.....	700
Bog water.....	650
Swamp water.....	425
Nutrient solution, 0.5 per cent.....	375

It is to be seen that all of the solutions decrease the swelling capacity of the agar below that displayed in distilled water, and that the greater reduction in the nutrient solution is to be attributed to the higher salt-content.

Plants of bogs and especially swamps are undoubtedly subjected to great variations in the composition of the water by reason of inundations and floods. It was thought pertinent to extend experiments in which alternations of solutions were made in such manner as to test the effect of previous history on the behavior of a biocolloid. Sections of agar-oat protein 0.18 mm. in thickness swelled 972 per cent in 12 hours at 17° to 19° C. and reached a total of 1,233 per cent at the end-point in 108 hours, which are equivalent to results previously attained and hence afford a fair basis of comparison with the following, in which a trio of sections swelled 2,361 per cent in distilled water at the end-point in 72 hours. Replacement of distilled water with swamp water was followed by a slow shrinkage, but this amounted to only 36 per cent of the original volume. No swelling agent yet tested has been found to reverse the action of another solution so fully as to bring the dimensions of the sections down to the dimensions which might be attained in the second agent alone.

Sections of a biocolloid consisting of 90 parts agar and 10 parts of bean protein to which 0.8 per cent of nutrient salts had been added, 0.18 mm. in thickness, were now swelled in swamp water at 18° to 20° C. The increase was measured at the end of 16 hours, at which time the total swelling was 1,082 per cent. The swamp water was now replaced with hundredth-normal citric acid-potassium nitrate for 36 hours, during which time no appreciable change was registered. Replacement of this solution with swamp water was followed by a resumption of the swelling, which carried the thickness of the sections to 1,388 per cent of the original, which is greater than that attained in the simple continuous swelling in swamp water.

Swamp water is high in salts, and it is probably this feature to which its influence on swelling is due. A test parallel to the above was made in which the sections were first swelled in a 0.5 per cent nutrient solution in which the salts are somewhat more concentrated than in the swamp water. A swelling of 888 per cent took place in 17 hours, at which time the pen of the auxograph was tracing a horizontal line. Replacement of the nutrient solution with the acidified potassium-

nitrate solution was followed by a very slight swelling. When this solution was replaced by swamp water an increase of 333 per cent followed in 40 hours. The two tests were parallel, except that the initial treatment in one case was with nutrient solution in which the salts were more concentrated than in the swamp water used in the other. The final swelling in the second case is greater and may be attributed to the initial salt action.

In a partial repetition of the above test, the sections placed in culture solution swelled 861 per cent in 20 hours. Lengthening the immersion in acidified potassium nitrate to 55 hours was accompanied by a swelling of 55 per cent. Replacement with distilled water set up a slow increase which resulted in a gain of 111 per cent in thickness in 40 hours. The total increase was 1,027 per cent, while the one finished in swamp water swelled 1,388 per cent.

The relative effects of swamp and bog water on biocolloids were tested in still another way. Plates of agar-oat protein were prepared in which strips of webbing of cotton were embedded in the soft material as it cooled for the purpose of testing the influence of certain purely mechanical features on swelling. Portions of the plates dried down to a thickness of 0.18 mm. in the clear portion of the plate and sections from this swelled 2,111 per cent in bog water and 1,195 per cent in swamp water at 15° C. Sections containing webbing were 0.58 mm. in thickness and the actual increase of such sections was 491 per cent in bog water and distilled water and 371 per cent in swamp water. If the increase be calculated on the assumption that the webbed sections included as much biocolloid as the free sections, the proportions would be 1,583 per cent in bog water and distilled water and 1,195 per cent in swamp water.

Swamp water has been found to affect absorption and swelling in the same manner as an equivalent solution of calcium sulphate. Swelling and absorption is retarded by swamp water in salted biocolloids and in sections of plants containing a large proportion of pentosans and a low protein-content. Biocolloids with a high protein and salt content, on the other hand, show an enhanced absorption in swamp water. Inferentially, plants of similar constitution would carry on absorption readily and thrive in swamp waters. Whether adaptation to swamp habitats actually takes this course is not known.

An extension of these measurements was made to ascertain the effects of water and soil solutions which were in common use at the Desert Laboratory upon a biocolloid, a mixture consisting of 6 parts of agar, 2 parts of mucilage of *Opuntia*, 1 part of gelatine, and 1 part of bean protein. This had been poured in the usual manner and dried to a thickness of 0.2 mm. Sections of the usual size were placed in dishes under the auxograph. Distilled water of the grade used in making up all of the solutions caused a swelling of 1,750 per cent; rain

water which had fallen on a slate roof and collected in a closed cement cistern gave a swelling of 1,500 per cent. The water from the system supplying the Desert Laboratory, taken from a well 40 feet in depth in the alluvium of the flats along the Santa Cruz River and pumped through an iron pipe line 6,000 feet long to a cement tank, produced a swelling of only 800 per cent. As a final test, a soil solution was used which was obtained by shaking up 600 grams of surface soil with 1,200 c.c. of distilled water and then allowed to stand for 12 hours. The filtered solution applied to sections in the same manner as the other waters induced a hydration of 900 per cent. (Fig. 10).

These measurements afford a standard of desirability of the water from these various sources for cultural work and for drinking purposes. Since growth consists in the main of the hydration of plasmatic colloids, the nutritive solution most favorable to this process would be an important factor in an environmental optimum. It was also possible to make tests of these natural waters with a biocolloid which included 6 parts agar, 2 parts prosopis gum, 1 part gelatine, and 1 part bean protein, to which had been added 0.2 per cent of culture solution. Such a mixture, like one containing gum arabic, shows high swelling in acids and less in salts, whether acid or alkaline. Swelling of plates 0.17 mm. in thickness were as shown herewith:

TABLE 67.

Distilled water (25° C.).....	p. ct. 1,760
Rain water (27° C.).....	1,794
Well water (27° C.).....	1,706
Soil water (25° C.).....	1,500

The higher temperatures at which the swellings in rain water and well water were made prevents direct comparison, but it may be supposed that a biocolloid already charged with salts to a point above the average of land plants would be hydrated in the dilute solution offered by the cistern water practically as readily as from distilled water. The figure given expresses the increase at a temperature 2° C. higher. The same would be true of the well water as compared with the soil solution. It is to be noted that the difference between the reaction in the solutions and in pure water is less than in the unsalted colloid. Of course, the substitution of prosopis gum for opuntia mucilage is also a factor. Relations to environmental conditions of some importance are suggested. The reactions of the halophytes should include some effects similar, in that there would be offered the phenomena of the swelling of cell-masses high in salts (fig. 10).

Some experiments in the modification of germ-plasm in 1905 resulted in the formation of embryos developing into individuals not entirely identical with the parental types. The essential feature of the experiment consisted in the successful introduction of various substances into the neighborhood of the embryo-sacs at the time that fertilization

was imminent, and when the first trials were made I had two main purposes in mind: first, to ascertain whether or not foreign substances could be introduced into ovaries in such manner as to affect the ovules with a minimum of traumatic effects, so that the ovaries might reach maturity; and secondly, to ascertain whether or not such changes could be produced in an early stage of sexual specialization before the development of the embryo-sac or after the union of the sexual elements in fertilization. The value of the results was much lessened by the fact that the direct effects of the reagents could not be identified. After some difficulty the actual diffusion of the liquids in the ovaries was ascertained by substituting dyes for the salt solutions, but there still remains to be determined the nature of the action of the reagents on the cell colloids.

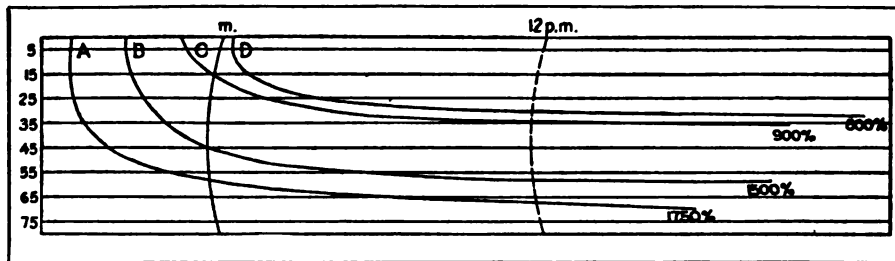

FIG. 10.—Tracing of auxographic record of swelling of plates consisting of 6 parts agar, 2 parts mucilage of *Opuntia*, 1 of gelatine, and 1 of bean protein, in distilled water, A; rain water, B; well water, C; and a soil solution, D.

The first step in such an examination would naturally be the measurement of the hydration effect. Plates of agar 90 parts and bean protein 10 parts, 0.25 mm. thick, were swelled to ascertain the possible imbibition effects. A series in the dark room at 15° to 16° C. gave the following measurements of expansion:

TABLE 68.

	<i>p. ct.</i>
Distilled water.....	1,220
Methylene blue.....	860
Iodine, sat. solution in distilled water.....	1,080

A third reagent used in the later series of ovarial treatments, zinc sulphate, was tested in the concentration of 1 part in 10,000 (0.00034 M) in comparison with distilled water and hydroxid on sections of agar-bean albumin. The swellings were as below:

TABLE 69.

	<i>p. ct.</i>
Distilled water.....	1,388
Zinc sulphate, 0.00034 M.....	833
Sodium hydroxid, 0.01 M.....	194

The characteristic high rate of swelling of agar-albumin is exhibited, the swelling in the hydroxid being but one-seventh that in water. The

zinc salt, although very dilute, retards swelling noticeably, and exerts a greater effect on the imbibition capacity than does either of the other reagents named.<sup>1</sup>

Whatever value may attach to this procedure, it seems reasonable to assume that salts less toxic in effect than those of zinc and identical with those already present in the embryo-sac offer the greatest promise, and their most intense effect might be secured when acidified.

The presence of free amino-groups in the cell and their rapid penetration of plasmatic structures makes it highly probable that some of these substances singly or in combination might diffuse throughout the cytoplasmic structure of the embryo-sac and also reach the chromosomes with a high degree of possibility of affecting their genetic content or potentiality.

---

<sup>1</sup> MacDougal and Spoehr. The effect of organic acids and their amino-compounds on the hydration of agar and on a biocolloid. *Proc. Soc. Exper. Biol. and Med.*, 16:33. 1918.

MacDougal, D. T. The experimental modification of germ-plasm. *Annals Mo. Bot. Garden*, 2:263-274, Feb.-Apr., 1915.



## VII. FLUCTUATING OR ALTERNATING HYDRATION EFFECTS. BASIS OF XEROPHILY AND SUCCULENCE.

The experiments described in the previous chapters have dealt chiefly with sections of colloidal material artificially compounded to represent the materials and conditions which affect hydration in plants. Measurements of the swelling of dried sections of this material have been used as a basis for comparison with the action of slices or sections of plant cell-masses similarly dehydrated or in living condition.

No estimate of results of this kind will be valid and no perspective of their bearing will be correct which does not take into account the fact that the growing parts of the higher plants contain 90 per cent or more water and that the colloids of the protoplast, the action of which makes for the distension or enlargement of growth, are even more highly hydrated. These gels also invariably contain the culture salts, in combination or simply adsorbed, and are inevitably in a condition of acidity resulting from their carbohydrate metabolism.

The elementary facts obtained by the experiments described in the foregoing pages made it possible to plan a series of treatments of hydrating material in which the previous experience of biocolloids would be apprehended in swellings in salts, acids, etc., in a sequence of interest to the physiologist, and to obtain additive, alternating, or superposed effects. Variations in the carbohydrate and proteinaceous substances of a colloidal mixture may not be readily produced to simulate the changes which form the basis of some of the most fundamentally important phenomena of the cell. The worker must approach this phase of the subject by studying the reactions of separate masses or lots of material compounded to represent various stages in the condition of the protoplasm. Something of this kind has been done in the measurement of the reactions of biocolloids of several kinds. It is of course impossible to imitate any of the important metabolic processes which make cell-colloids continuously acting machines, although no hint has been found of any source of energy or directive action outside of surface tension and chemical action.

In the subjection of colloidal masses to the action of hydrating solutions, as described in the following pages, it is obvious that the soluble constituents of the sections would be partially and unequally removed with every change in the solutions in which they were submerged, and while the fact that the colloidal mass changed its composition continuously during the immersion in the various reagents, yet it can not be said that these alterations were identical with those of the growing cell.<sup>1</sup> Some highly suggestive results or situations were produced, however, by the replacements of hydrating solutions, as described in following pages.

---

NOTE.—All measurements of swelling and shrinkage are given in terms of original or dried thickness of sections.—AUTHOR.

<sup>1</sup> MacDougal and Spoehr. The effects of acids and salts on biocolloids. *Science*, 46:269. 1917.

An experiment of this kind was carried out July 30 to August 9, 1917, in the equable-temperature chambers of the Coastal Laboratory at 15° to 16° C., in which sections composed of 9 parts agar and 1 part bean protein were subjected to alternating action of acids and hydroxid after they had first been swelled in water for 5 hours. Citric, malic, and formic acids were used in separate sets at hundredth-normal concentration, but no determination was made of the hydrogen-ion concentration, and as the initial swellings in water were widely divergent, the final totals have no especial significance, entire interest lying in the changes in volume resulting from the replacements. (See fig. 11.)

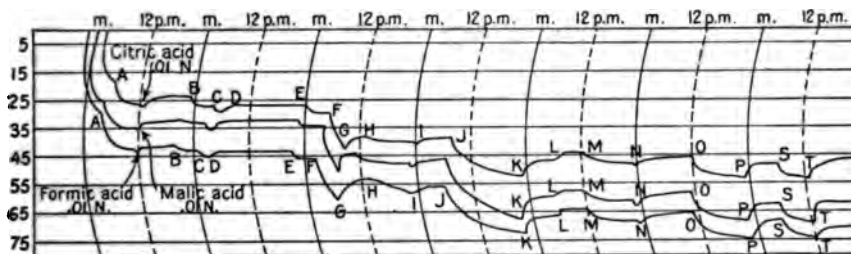

FIG. 11.—Record of variations in thickness of sections of agar and bean protein subjected to the action of water, acids, and alkalis, as described in text pages 79 and 80.

Trios of sections which were 0.25 mm. in thickness were placed in dishes into which distilled water was poured in the usual manner. At the end of 5 hours, designated as A on the tracing, the water was drawn off by a pipette and a solution of hundredth-normal sodium hydroxid substituted, which was followed by an expansion which reached almost to the possible total of 580 to 860 per cent of the original dried sections in 8 hours. At the end of this time the sections were in an advanced stage of hydration and were also probably impregnated with salts formed by potassium with the carbohydrates and proteins in the gel, and the possible presence of these compounds as modified by subsequent experiences must be kept in mind.

The three acids were now added to the separate sets of sections, and from this point their experiences diverge. All agreed in undergoing a retraction during the next 9 hours which was most pronounced in the citric acid. Shrinkage at a slow rate was still in progress at the end of this period, B, when the acid solutions were removed and distilled water substituted. No effort was made to wash the sections which were saturated with the acid and salt, and the operation resulted simply in a reduced acidity in which some slight swelling took place during the 5 hours ending at C, at which time the reaction was practically at an end.

The hydroxid was now used for the second time, replacing the acid, for 2 hours, in which time a further slight swelling ensued. Acids

were again used at *D* and a slow shrinkage again set in which followed on during the 18 hours until the change was made at *E* to hydroxid, which, as before, simply neutralized the acid and increased the salt-content, with the result that the volume of the colloid swelled to the dimensions occupied before the last treatment with acid. At the end of the 5 hours, *F*, the hydroxid was removed and water, renewed once, poured into the dishes. The effect was very marked, as a rapid swelling ensued during the next 4 hours, at the end of which time it was in progress at an undiminished rate, being greatest in the formic and least in the citric acid. The sections now contained a large proportion of water, sufficient to bring them into the condition of hydration of active protoplasm, and the addition of the acids at *G* arrested the swelling abruptly and caused a shrinkage which was diminishing at the end of 4 hours. The shrinkage was checked by replacement with water at *H* and a slight swelling took place in the ensuing 11 hours.

The water now being replaced by hydroxid, a sudden slight expansion occurred in all of the sections, followed by a shrinkage which had not ceased entirely at the end of 9 hours, during which period additional salts were being formed in the colloidal structure. Now, when the hydroxid was partially washed out by water at *J*, a swelling ensued which in 15 hours brought the sections very nearly to their final thickness and consequently near their maximum imbibition capacity. It is in this condition, of course, that growing protoplasts are normally active. The greatest expansion in this phase was in the material treated previously with malic acid.

The addition of hydroxid (*K*) was now followed by a marked shrinkage which had not ceased at the end of 8 hours. Replacement of the hydroxid with acid at *L* caused a further abrupt retraction which soon ceased, and after 5 hours the acid was replaced with water once renewed (*M*), only a slight swelling resulting during the next 10 hours. Again hydroxid (*N*) caused a sudden expansion to be followed by a slow shrinkage which had not reached its end in 13 hours. Water now following hydroxid at *O*, a much greater expansion took place than when water followed acid. Alkalosis at *P* now came after an hydroxid-water period and was not followed by the abrupt enlargement consequent upon adding hydroxid to the colloid after an acid-water period. The shrinkage, however, was as marked as in previous experiences, and had not ended in 8 hours.

Replacement with water at *S* was followed by an expansion which had not ceased at the end of 6 hours. Finally, acids caused a diminution the most marked of any produced by these substances. Both acids and hydroxids caused the most marked changes in the highly hydrated and salted sections near the end of the week over which the

experiments had been extended. It is to be noted that, in addition to hydration and possible salt formation, the colloid was also undergoing some alteration by the unequal solution out of the solution of protein and agar.

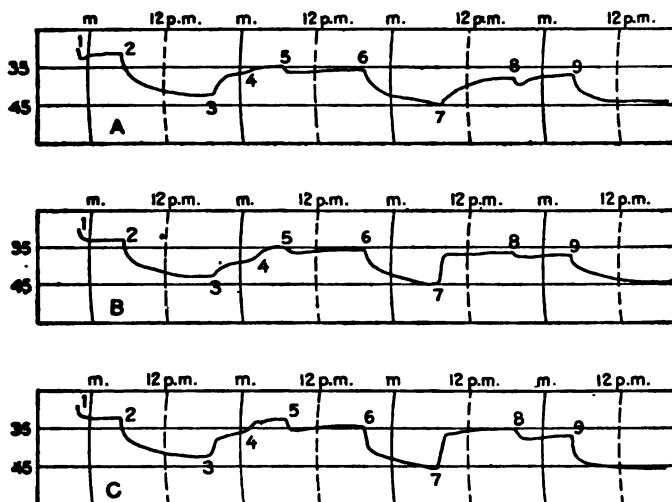

FIG. 12.  
Continuation of record of variations of sections of agar and bean protein in fig. 11. For description see text, pages 81 and 82.

New sheets were fitted to the recorder of the auxograph and arrangements made to follow further changes (see fig. 12). During the next 4 days an additional swelling of 280 per cent in the malic series, 320 per cent in the citric, and 300 per cent in the formic were recorded. Replacement of the acid by hydroxid (1) resulted first in an expansion which was partially lost in 7 hours, so that the net gain was very light. When the hydroxid was washed off (2) hydration in distilled water was followed by expansion of lesser amplitude than in the previous procedure of this kind, but it had not ceased at the end of 14 hours. A diminution in each repetition was found. Hydroxid (3) failed to bring the sections back to the dimensions preceding the last hydration. Replacement of the hydroxid by acid (4) caused a further slight contraction, but not to the last pre-hydration dimensions. In fact, every hydration included an irreversible element. Hydroxid (5) again produced shrinkage, and then contraction which soon ceased. After 13 hours in hydroxid, water applied and renewed (6) produced a swelling which was in progress at the end of 12 hours. Replacement with acids (7) was followed by very abrupt shrinkages which were more gradual in formic acid. Substitution of hydroxid after 11 hours at 8 was followed by the expected initial expansion and subsequent shrinkage. The final hydration (9) on the tenth day of the test gave swellings with net expansions of 7, 9, and 8, as compared with 21, 18, and 17 on the sixth day. The biocolloid is thus seen to progress through a period of reactions of increasing amplitude to a climax, followed by one of diminishing alterations in

water. Such progress is probably accompanied by, or consequent upon, changes in the proteins and in the pentosans. On the other hand, as the sections come nearer to their total imbibitional or hydration capacity, they are more sensitive to acidity and not only the speed but the amount of retraction increases.

Another series was based on the behavior of an agar (90 parts) bean albumen (10 parts) mixture in plates 0.18 mm. in thickness. Three sets of sections were given treatment as nearly identical as possible, a special feature being made of the action of salts.

An initial swelling of 1,055 to 1,222 per cent, averaging 1,137 per cent, was first produced in 7 hours in distilled water, at which time it is evident the plates had increased to a thickness of about 2 mm., or one-half of the total displayed in the test. (See fig. 13.) The replace-

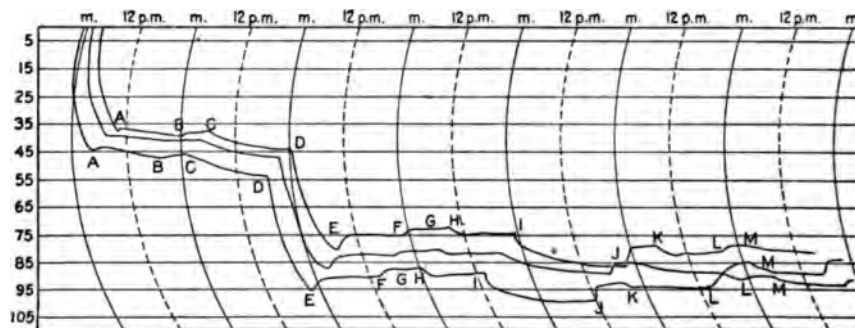

FIG. 13.—Variations in thickness in sections of agar and bean albumen subjected to the action of acids, salts, and hydroxid.

ment of the water by a hundredth-molar solution of potassium nitrate (A) for 14 hours was characterized by a slight initial shrinkage, followed by very slow swelling, which was probably accompanied by a solution of the albumin from the sections. Replacement of the salt solution by another one acidified by a hundredth-normal citric-acid solution (B), produced a shrinkage which brought the dimensions of the sections to about that at the end of the initial swelling in water. The material might now be considered as a biocolloid containing some salt and acidified to a point probably equivalent to conditions in living material. Replacement of the acidified salt with alkaline salt of the same concentration resulted in a swelling averaging 200 per cent of the original thickness of the dried plate.

The sections were now washed (D) and allowed to swell for 9 hours in distilled water, making an increase of over 1,100 per cent and, as will be obvious, bringing the water-content of the biocolloid to a point nearing the maximum capacity.

Replacement of water by an alkaline salt solution (E) now produced a greater shrinkage than when the biocolloid had a water-content about a half less, the loss being 200 per cent of the original thick-

ness. Replacement with acid (*F*) resulted in a further slight shrinkage, no noticeable loss ensuing when the acid was replaced by acidified salt (*G*). Replacement with alkaline salt (*H*) was followed by an increase which had ceased at the end of 4 hours. Water now caused a slow continued swelling (*I*), at which time the maximum size of the sections was reached and they had swelled 2,400 to 2,800 per cent of the diameter of the dried plate.

Replacement of the water by an acidified solution (*J*) resulted in a very rapid shrinkage, which was nearly complete in an hour and reduced the sections nearly 200 per cent of the original. Replacement of the acidified salt by water (*K*), which was renewed three times, regained only about half of the thickness lost in the acidified salt. It is to be remembered that the sections were in a condition of acidosis, and this would not be reduced below a certain point until alkali was introduced. This was done in an alkaline salt (*L*), which produced a very slight shrinkage. The swelling in water following this treatment was of such reduced amplitude that the measurements were discontinued. The successive treatments had resulted in the incorporation of water to the full imbibition capacity of the colloid, and the reagents had produced such changes that mere variations in acidity, alkalinity, etc., caused but little variation in this amount and in the volume of the sections, a condition in general analogous to that of a mature organ.

A series of tests were now planned to induce alterations in sections in which imbibition was first carried to a degree near the saturation-point. Sections of agar 90 parts, bean protein 10 parts, 0.16 mm. in thickness, swelled 2,156 per cent in 18.5 hours at 16° to 18° C., and the rate of expansion had fallen very low. Substitution of a hundredth-normal potassium-nitrate solution checked further increase and induced a very slight shrinkage in 6.5 hours, and no perceptible alteration took place by the substitution of citric acid (0.01 M) for 15.5 hours. Replacement with potassium hydroxid + potassium nitrate (0.01 M) resulted in a swelling of 156 per cent of the original dimensions in 8 hours, at the end of which time this action had entirely terminated. The sections now being in an alkaline condition, their immersion in water was followed by an increase of 1,250 per cent of the original dimensions, the total now being 3,406 per cent.

Replacement of the water by a hundredth-normal solution of potassium nitrate and citric acid resulted in a greater change than at a lower water-content, the shrinkage now being 190 per cent of the original diameter of the air-dry plate. When the sections had swelled but 2,156 per cent, the action of a similar solution did but little more than check swelling.

The biocolloid at this last point was equivalent to a protoplasm in its water-relations which contained over 95 per cent water and less than 5 per cent dry matter. In a later stage the biocolloid was made

up of less than 3 per cent dry matter and more than 97 per cent water, and hence approximated the dispersion of active protoplasm.

Other sections from the same plate swelled 2,094 per cent in 18.5 hours at 16° to 18° C. The use of potassium nitrate and citric acid (0.01 N) resulted in a shrinkage of less than a hundred per cent within an hour, after which the volume was stationary. As the experiences of the two sets of sections had been identical hitherto, it is interesting to note that in this stage of imbibition (95 per cent water) acidified salt produced more shrinkage than the salt alone, a result in harmony with those obtained by swelling biocolloids. Imbibition in the salt being generally greater than in the acidified salt, replacement of the acidified salt with the alkaline salt was followed by a swelling amounting to over 300 per cent of the original thickness of the sections in 9 hours, at the end of which time the swelling had not reached its limit. Replacement with water speeded the imbibition to a rate which made an increase of over 800 per cent in 9 hours. The sections now contained nearly 97 per cent water, having swelled 3,156 per cent, and when the water in the dish was replaced with acidified potassium nitrate (0.01 M), the shrinkage was greater than in the previous experience, now amounting to 300 per cent of the original thickness of the sections. A further shrinkage followed the substitution of alkaline salt solution.

Tests were arranged to ascertain the effect of the initial hydration medium, using salts and acidified salts. Trios of sections of agar 90 parts and oat protein 10 parts, 0.18 mm. in thickness, were put under the auxograph in a darkened chamber which remained steadily at 18° C. during the week in which the measurements were made.

The sections which were immersed in hundredth-molar potassium nitrate reached a size within 100 per cent of the possible total in 16.5 hours, at which time the expansion was about 1,200 per cent. The replacement of the salt by distilled water which was renewed twice induced an additional expansion of 1,750 per cent in 22.5 hours, which was the practical limit of the sections. Replacement with hundredth-normal acidified potassium nitrate resulted in a shrinkage of about 100 per cent, the movement being complete in 6 hours. Replacement of the acidified salt with water (renewed three times) induced a slow, long-continued swelling, which, at the end of 18.5 hours, had resulted in an increase of about 100 per cent, and which carried the sections back to the maximum thickness attained before the acidified salt was added. The water was now replaced by a simple hundredth-normal potassium-nitrate solution, which produced a shrinkage slightly less than that displayed 24 hours before in acidified salt. This was followed by a long-continued swelling, which again, in 21 hours, brought the sections to the maximum thickness. The change to an acidified salt solution resulted in a shrinkage about equivalent to the

previous one, and the experiment was discontinued after a total period of 100 hours.

The use of hundredth-normal potassium nitrate-citric acid as the first solution caused a swelling of 708 per cent in 7 hours, at which time the rate of increase was very slow and would not have carried the thickness to more than 800 per cent of the original. Replacement of the acidified salt by the salt alone in the same concentration and its renewal accelerated imbibition, which proceeded at a rate which lessened very slowly for 63 hours. The swelling was at first at the rate of 100 per cent in 4 hours and about 25 per cent during the last 4 hours. The increase during this period of 87 hours was about 700 per cent, making the total increase over 1,400 per cent. The behavior of the colloid during this period was that of a plant with diminishing acidity.

The salt was now pipetted off and replaced with distilled water which was renewed. The acceleration following was so abrupt that the rate jumped from 25 per cent in 4 hours to 750 per cent in 2 hours. The swelling at the end of 24 hours was 1,778 per cent, at which time increase was still in progress. The total increase now amounted to 3,195 per cent. The unsatisfied capacity would have doubtless carried the swelling to a thickness as great as any yet observed in any of the biocolloids and in excess of the sections which were swelled initially in the salt alone.

The mass was now nearly 97 per cent water. Replacement of the water by acidified salt solution was followed by a shrinkage of about 200 per cent of the original thickness of the sections in 8 hours. When this was washed out, the loss was regained in a few hours. These sections were now set aside for desiccation. The final period of 16 hours in the swelling was in distilled water, so that the acidified potassium nitrate in which the sections had been immersed for the preceding 8 hours must have been reduced to a very small amount.

The last desiccation had left the sections warped to some extent, which interfered with accurate remeasurements, but the thickness had been reduced from 0.18 to 0.16 mm. and even thinner. The irregularities of course operated to introduce some error in the swelling, which would make the total appear to be 100 to 200 per cent less than it should be.

The swelling in distilled water at 18° to 20° C. now progressed over a period of about 96 hours, reaching a total of 1,625 per cent. Both the amount of the total and the length of time necessary to reach full capacity would indicate that the sections still contained some of the protein or its derivatives and perhaps some of the salts. Agar alone would attain full capacity at a lesser volume and in a shorter time.

A second set of sections of agar 90 and oat protein 10 parts were first treated with acidified potassium nitrate, in which the swelling was about 500 per cent (the solution being freshly made) in 16 hours. This



was now washed out with water and the swelling, which had been interrupted in the previous test, was allowed to go on for 147 hours. Swelling was still in progress after 6 days of continuous imbibition, the increase being 1,833 per cent. The total increase up to this time was 2,388 per cent. The shrinkage caused by a solution of acidified potassium nitrate was very slight, being less than 100 per cent of the original, and was scarcely more than the effect of the potassium nitrate which was first applied. The original thickness of 0.18 mm. was now reduced to 0.16 mm., much of this loss being attributable to the solution out of some of the water-soluble oat protein and some of the agar (see p. 107). The sections also probably contained some salt and probably a trace of acid.

The trio of sections were placed under the auxograph in a chamber where the temperature of the distilled water in which they were immersed varied between 17° to 20° C. in the 6 days during which the test was carried on. The initial swelling, in contrast with the action of fresh sections, was very slow. Furthermore, the increase was continued over a long period, and came to a total of 938 per cent, or less than one-half of the original expansion.

Sections of plates 0.18 mm. in thickness of agar 90 parts and bean protein 10 parts, to which 0.85 per cent of nutrient salts had been added, were tested in the chamber at 16° to 19° C. The initial treatment with distilled water induced a swelling 1,861 per cent in 20 hours, during which time the nutrient salts must have been partially dissolved out, so that at the end of this period the liquid was a salt solution in which none of the various components was as concentrated as 0.001 M, since about 30 c.c. of water was poured in the dish. The capacity for increase in this solution having been approached, the water (or saline solution) was replaced with a hundredth-normal solution of malic acid, which caused a shrinkage of about 100 per cent in 2 or 3 hours. After 7 hours the acid was replaced with distilled water, and a slow swelling ensued. The effects of the alternations here are not separable from those in which the salt is incorporated in the colloid with the first swelling solution.

A similar set of sections containing nutrient salts were prepared by cutting a trio of strips 7 mm. in length to be placed under the auxograph. A free strip 30 mm. long was also placed in the dish.

The initial immersion in 0.5 per cent nutrient solution was practically complete as to its swelling effects in 18 hours, with an increase of 850 per cent. Substitution of hundredth-normal acidified potassium nitrate caused a total additional increase of 75 per cent in 22.5 hours. Replacement of this solution with an alkaline solution of potassium nitrate of the same concentration was followed by a further swelling of 350 per cent in 44 hours. The total swelling of the sections during a period of 110 hours was 1,250 per cent. The concentration of the

salts was reduced during one period of 23.5 hours and during the remainder of the time the concentration was about a hundredth molar at a temperature of 18° to 21° C. No appreciable change in length of the tested trio of sections or of the free long strip occurred (see p. 19).

The effects of swamp water, which has already been shown to retard hydration, were tested in this connection. The first lot of water of this kind was procured from the sedge-grass swamps near Anoka, Minnesota. Sections of agar 90 and oat protein 10 parts, which were 0.18 mm. in thickness, were swelled in this at 17° to 19° C. Imbibition was rapid during the first 12 hours, during which time a total enlargement of 972 per cent took place. At the end of this time the rate had decreased notably, but was maintained in such manner that in 4 days an additional swelling of 361 per cent was recorded. The volume was now practically stationary and the test was closed at the end of 108 hours. This long-continued swelling at a low rate and low total was in contrast with swellings of similar sections in distilled water and in nutritive salts.

The trio of sections placed in distilled water at the same time as the above swelled 2,361 per cent in 3 days, and as increase had ceased, the distilled water was replaced with swamp water, with the result that a slow shrinkage ensued, which, however, amounted to only 36 per cent of the original volume in 2 days.

It was next thought important to test the swelling of sections containing salts in swamp water, and a mixture of agar 90 parts, bean protein 10 parts, and nutrient salts 0.85, 0.18 mm. in thickness, was swelled at the temperatures of 17° to 19° C. The initial swelling was practically complete in 16 hours, at which time an increase of 1,082 per cent had taken place. Replacement with acidified potassium nitrate, hundredth normal, for 36 hours caused no appreciable change in volume, but when this solution was washed away in swamp water, swelling was resumed and a further increase occurred, most of which took place in the first 4 hours, but which was still in progress at a very slow rate at the end of 38 hours. The enlargement in the swamp water during this final period was 306 per cent, the total swelling being 1,388 per cent.

Sections identical with the above were first placed in a 0.5 per cent nutrient solution, in which a swelling of 888 per cent occurred in 17 hours, at which time the pen of the auxograph was tracing a horizontal line. Replacement with acidified potassium nitrate produced no effect beyond a very slight swelling. When the acid solution was washed away with the swamp water swelling began and an increase amounting to 333 per cent followed in 40 hours. This final action was fairly equivalent to that of the preceding series, except that the substitution of swamp water for the acidified salt was followed by a much slower but more extended rate of initial swelling.

Another test was made for the purpose of comparison of the effects of the swamp water with those of a solution of nutrient salts in which the initial swelling in the nutrient solution was 861 per cent in 20 hours, which was less than in swamp water. A solution of acidified potassium nitrate was substituted and a swelling of 55 per cent ensued in 55 hours. Replacement of the acidified salt solution by distilled water was followed by a long-continued swelling which increased the volume 111 per cent in 40 hours. The total increase of this section was thus 1,027 per cent, as compared with 1,333 per cent in bog water alone.

The obvious importance of these reactions is amply illustrated by the changes in environmental conditions to which many aquatic plants are subjected in the course of a season or even in a day.

Growth in all probability implies the incorporation of new material in the colloid which adds to the hydration total of the mass. It is not easy to arrange the introduction of unhydrated particles in a swelling mass, but it was deemed worth while to bring a desiccated trio of sections into swelling under a similar trio which had already undergone some expansion.

Three sections of an agar 90, peptone 10 parts, 0.18 mm. in thickness, were swelled in distilled water until an expansion of 1,195 per cent had been reached in 4 hours; a second series of sections were gently slid under the first lot, the pen was readjusted to register continuously, and a fresh lot of water was added (fig. 14).

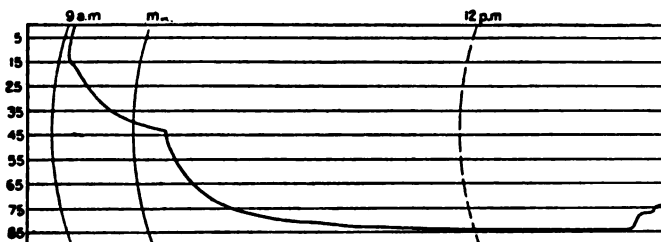

FIG. 14.  
Course of swelling of a double trio of sections of agar and peptone, the second being added after the first was partially hydrated. See text, page 88.

A swelling of the two trios now followed which reached satisfaction in about 14 hours, which amounted to 708 per cent, calculated on the thickness of both. Most of this swelling, however, was in the freshly added sections, in which the swelling was 1,083 per cent in 4 hours, and a lesser amount was due of course to the original trio. The final total of the pair of trios swelled only 1,153 per cent, while the first set had increased 1,195 per cent before the second pair was added and had not yet completed its swelling. It seems fair to infer that increase of thickness diminishes the proportionate increase.

A second test was made in which the swelling of the first trio reached about 800 per cent in 2 hours and then a fresh section was thrust under

one of the old ones. The swelling during the next two and a half hours was equivalent to 500 per cent on the basis of the average thickness of the four sections in action.

A second fresh section was placed under another old one, making five sections in action. The swelling during the next 3 hours was something over 300 per cent, calculated on the basis of the five sections engaged. The third fresh section was now added, giving a preparation in which sections were included in four different stages of swelling, with an initial average thickness of 0.36 mm. The swelling during the next three and a half hours was about 225 per cent of the initial thickness and reached an end-point 20 hours after the experiment was begun at 1,333 per cent of the total, which was in excess of that reached in the previous test. The temperature underwent a range of from 15° to 22° C. (fig. 15).

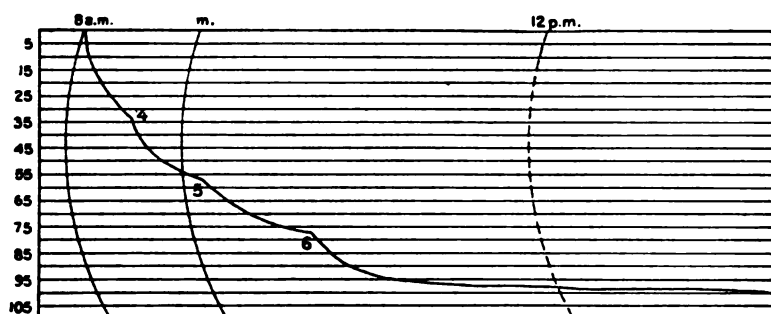

FIG. 15.—Courses of swelling of sections of agar and peptone, a fourth, fifth, and sixth fresh (dry) section being added as indicated.

The water was now removed from the dishes and the double trio of sections was subjected to the action of a 2 M solution of calcium chloride. A shrinkage followed which terminated with some abruptness at the end of an hour and reduced the thickness of the swelled sections 1.05 mm. or nearly 300 per cent of the original. Calculated on the basis of the swelled sections, which had reached a total average

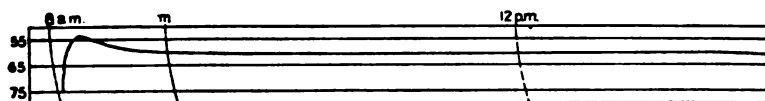

FIG. 16.—Variations in volume of double trio of sections of agar and peptone which had reached full hydration in distilled water and were then immersed in calcium chloride, 2M.

thickness of 4.8 mm., the reduction was nearly 22 per cent. A swelling now followed and practically half of the thickness lost was regained. Most of this was completed within 2 hours, after which a very slow rate of increase followed, which was not at an end at the close of the third day. This test also was carried on at room temperature, which underwent a wide variation, as noted above (fig. 16).

These elementary experiments open a field of possibilities as to the incorporation of new material in masses of swelling colloids, in exemplification of some phases of cell-mechanics, inclusive of the action of embryonic cells in growing regions. The author, in collaboration with Spoehr and Richards, has recently been able to outline the manner in which the xerophilous and the succulent types of shoots or organs are due to the action of such superposed effects in the cell colloids. A series of detailed analyses of the carbohydrate-content of the opuntias, which was arranged to determine the principal sugars not only during developmental stages, but also to follow the changes throughout the seasons, established the fact that when these plants were subjected to long periods of drought, resulting in partial desiccation, polysaccharids were dehydrated, with the result that the sugars, which have a low water capacity, became converted into pentosans or mucilages, which have a large imbibition capacity. This fact was amply confirmed by the coefficients of swelling which were obtained in my own tests, which ran through several years.

Following this, the fortunate discovery was made that *Castilleja latifolia*, which is native to the region about the Coastal Laboratory, has thin, highly acid leaves when growing under mesophytic conditions, but has less-acid succulent leaves in arid locations, the increased size of the leaves being due to the hypertrophy of the thin-walled parenchymatous tissues. The hydration reactions of the two types of leaves in a fresh and dried condition are shown in table 70, which gives the swellings in 0.01 normal citric acid at 15° C.

TABLE 70.

	Thin.		Succulent.	
	Thickness.	Swelling.	Thickness.	Swelling.
	<i>mm.</i>	<i>p. ct.</i>	<i>mm.</i>	<i>p. ct.</i>
Fresh leaves.....	{ 0.4 .41	{ 125 184	{ 1.4 1.4	{ 21 25
Above leaves dried and re-hydrated..... (Expansion in terms of dried thickness.)	{ .23 .25	{ 42 20	{ 0.5-0.6 0.63	{ 95 91
Fresh-dried leaves..... (Expansion in terms of dried thickness.)	{ .38 .2 .38 .2	{ ..... 25 ..... 62	{ 1.2 .5 1.1 .38	{ ..... 120 ..... 92

In the interpretation of these results, it is to be noted that drying, both from the fresh state and from the hydrated condition, reduces the hydration capacity of the thin leaves, but not of the succulent ones. The principal changes in hydration include the extraction of acids and salts as well as the hexoses, while the mucilaginous pentosans diffuse

not at all or very slowly. The swelling of the succulent leaves is therefore high after extraction by reason of the presence of these substances, which have been partially freed from the retarding action of the organic acids and salts.<sup>1</sup>

The conversion of the diffusible sugars to the mucilaginous pentosans is one of the alterations which may result in the cell as a result of partial desiccation, with a striking morphogenetic result as indicated. Under certain conditions of desiccation, the lessening of the water-content of the cell accelerates the formation of the anhydrides of which wall material is composed, with the result that the hydration capacity of the product in this case is less than that of the polysaccharids, and in addition to this direct diminution of the water-absorbing material of the cell, the production of the heavy wall at an early stage of the development of the cell checks growth, resulting in the restricted shoots or organs with indurated membranes which are characteristic of xerophytic plants.<sup>2</sup> Two striking and highly important vegetational types are thus seen to result more or less directly from the action of the environment upon the cell-colloids, in accordance with a view expressed by the author in a previous publication.

---

<sup>1</sup> MacDougal, Richards, and Spoehr. The basis of succulence in plants. *Bot. Gas.*, 67: 405. 1919.

<sup>2</sup> MacDougal, D. T. The Salton Sea, etc. *Carnegie Inst. Wash. Pub. No. 193.* 1914. See p. 179. Also MacDougal and Spoehr. The origination of xerophytism. *Plant World*, 21: 245. 1918.

## VIII. WATER DEFICIT, OR UNSATISFIED HYDRATION CAPACITY.

Much of the present confusion as to the nature, mechanism, and course of growth is due to the fact that premature attempts have been made to institute comparisons in measurements derived from organisms fundamentally different.

Thus, the growth of bacteria consists in the enlargement to a unit size of cells high in proteins which become independent when this volume is reached, and not being attached to other cells, their presence does not directly affect the rate of growth calculated upon their number, except in so far as their excretions in the medium may do so. Furthermore, these, as well as organs which are submerged in the liquid nutrient media, are in a condition approaching complete hydration in the complex of conditions in which they live, and these may vary only within very narrow limits in many cases.

Growth in the higher complex plants implies the multiplication of embryonic cells and the development of the greater number of them into special static tissues to which the growing cells are inseparably attached. Thus an internode, or a leaf, barely makes its appearance before some of its cells have passed beyond the growing-stage and into a condition of lessening change to a nearly static condition of maturity. Enormous numbers of senescent and highly specialized cells are formed through which the water-supply of the growing cells must pass and which compete for the supply. The water-deficit, or the amount which a cell-mass in the plant may take up, may therefore vary widely, as, in addition to the internal changes, water is constantly being lost from the surfaces by transpiration. An instrument attached to the terminal portion of a plant records the changes in volume of cell-masses in all of the possible stages between the apex and the base of the internode or the point at which the stem may be fixed in the experimental preparations.

The tips of roots offer a generalized type of growth, which has been the subject of more experimentation than any other part of the higher plants. Even here the measurements invariably include the enlargements of masses of embryonic cells by imbibition alone, the intermediate stage in which the increase in the size of the vacuole doubtless plays an important rôle, to a final stage in which imbibition again may be the only force of distension. Only in individual unicellular organisms and in such structures as pollen-tubes may growth-enlargements be dealt with to the exclusion of variations of  tissues.

Again, growth is a resultant of the play of molecular forces in surface tensions and of a series of metabolic transformations which features notable differentiations are found in the tissues.

The main features of imbibition are determined by the carbohydrate-protein ratio and the presence of salts. Animals and some vegetal organisms are high in proteins. The vacuole and the external layer of the protoplasmic units in plants give a play of osmotic activities not duplicated in the animal; and lastly, as has been so clearly established by the work of Dr. H. A. Spoehr, the plant has a characteristic carbohydrate metabolism with the capacity for the synthesis and combination of the amino-acids, while in animal processes metabolism is more largely concerned with the proteins, and amino-acids result chiefly or entirely by disintegration of albumins.

The ordinary conception of growth implying the changes in dimensions of the developing parts of organs, shoots, roots, etc., is, however, a well-rounded one of sound value and worthy of attention as a unified procedure. The ultimate physical forces concerned are those which find play in elastic gels, and the interaction of these forces may be modified by the self-altered composition of the living colloids and by the action of external agencies under the influence of which these colloids operate.

The course of growth in the succulents will come in for a large share of attention in the following chapters. The form of the organs of such plants facilitates the making of observations in which the actual temperature of the living mass may be found with some exactness, and the large bulk which characterizes them makes it comparatively easy to obtain analyses showing the varying proportions of the constituents of importance in growth. Some attention has been given to plants with thin stems and slender leaves, which in reality constitute the dominant vegetative type of plants.

The arrangement of imbibition tests of the growing terminal internodes of stems, and other organs, and the interpretation of the results was made upon the basis of the supposition that such material was in effect a complicated salted colloid, with an altering and unsatisfied hydration capacity. The manner in which saturation might be reached by immersion in various solutions might well offer some profitable comparisons with the behavior of biocolloids of known composition and structure. The earlier trials were made with the growing parts of stems of *Phytolacca decandra*, *Micrampelis californica*, and *Rudbeckia laciniata*. The young internodes furnished sections about 1 cm. long and of a thickness from 4 to 8 mm. A tangential slice was cut from one side to remove a segment of the fibrovascular tissue, and the plane surface exposed served to seat the sections firmly in the glass testing-dishes of the auxographs. The first series was made with distilled water, sodium or potassium hydroxide, and citric and formic acids, all in hundredth-normal concentration.

The series which were run in a day-lighted laboratory at temperatures of 18° to 22° C. agreed in swelling most in distilled water, less in



the hydroxid, and least in the organic acids mentioned, in proportions of 40, 20, and 15 in *Rudbeckia*, and 30, 25, and 15 in *Micrampelis*. *Phytolacca* gave proportions of 30, 25, and 12 under the same circumstances. It was noticeable that distension due to swelling by these acids was relaxed after a few hours, probably due to the solution out of some of the colloidal contents of the cells.

Further tests were made with the stalks of *Rudbeckia* bearing heads of flowers about ready to open. The greater part of the total growth had been accomplished, although they were still in rapid action and the material for the developing flowers was being drawn from them. Tangential slices less than 1 mm. in thickness were removed, leaving the stalks 4 mm. in thickness at the larger end and about 3.4 mm. at the smaller. Sections about 1 cm. in length were cut from four such stalks and the whole number was divided into two lots. One lot of sections was taken into the dark room and swelled at 18° C. and the others were set on a window-ledge to become air-dry. The average thickness was taken to be 3.7 mm. Twenty hours later swellings of 6.8 per cent in distilled water, 4.8 per cent in alkali, and 1.4 per cent in acid had been made (fig. 17). Actual enlargement by imbibition in the acid had lasted only about an hour, after which a shrinkage ensued that reduced the thickness 5.4 per cent from the original volume and 6.8 per cent from the maximum. The decrease here and the increase in water and in hydroxid were all in progress at the close of the test. The dried sections came down to about half of their original diameter, but, on account of the irregular shapes assumed, could not be measured with accuracy. Trios of these under the auxograph gave swellings of 41.9 per cent in distilled water, 21.6 per cent in hundredth-normal citric acid, and 37.8 per cent in hundredth-normal sodium hydroxid. The sections were thus seen to return to about their original size in the living condition in distilled water—nearly this size in hydroxid, but far short of it in the acid solution, after the manner of a salted biocolloid consisting of a large proportion of carbohydrate and a smaller one of protein. Here, as in all comparisons between the hydration of living and of dried sections, it must be taken into account that in the desiccation

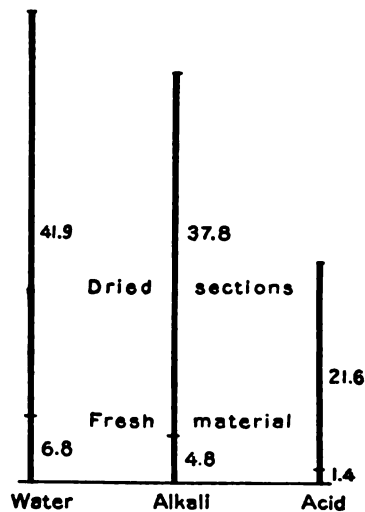

FIG. 17.—Swelling reactions of fresh and dried flower-stalks of *Rudbeckia*, in percentages of original thickness. The proportionate increase of dried sections is denoted by the heights of the vertical lines, and that of fresh sections by the marks near base.

of cell-masses, the acids, salts, sugars, etc., in the vacuoles and syneretic cavities of the protoplasm increase in concentration as the dehydration proceeds, until as the end is neared these substances are taken up by the protoplasmic colloids from solutions which may be saturated.

The swelling of a living section continues until hydration capacity is satisfied or balanced against the mechanical restraint of the cell-walls, and includes the possibilities of osmotic action by reason of their differential action. The colloids are subjected to the action of the salts and acids only to attenuations in which these substances are usually present. When desiccated sections are swelled, the cell colloids are now in the condition of having adsorbed substances previously in great dispersion and the external layers of the cells now exercise only the effect of a dense filter-paper; consequently any osmotic pressure which might be set up is soon equalized, and hence contributes but little to the expansion of the cells.

Returning to the matter of the fresh sections of *Rudbeckia*, the nature of the increase in hydration capacity of the material with the march of development may be set forth more clearly by the figures in table 71, in which the percentages of swelling are multiplied by 10.

TABLE 71.—Swelling of *Rudbeckia*.

	Young.	Mature.	Dried.
	<i>p. ct.</i>	<i>p. ct.</i>	<i>p. ct.</i>
Water.....	40	68	419
Acid.....	68	14	48
Hydroxid...	419	216	378

Swelling was greatest in water in both young and old stalks and the increase of the hydrogen-ion concentration or acidity of the medium resulted in reducing the final hydration capacity of the tissues, more water being taken up when hydroxid was used, but the total capacity being less than in water. The desiccation of the stems, with attendant possible coagulatory effects, was accompanied by an increase in hydration capacity in the acid solutions. The greater swelling shown by old tissues suggests increased pentosan or mucilage content rather than a deficit due to loss of water.

No opportunity was lost to make measurements of other material which might possibly show the diversity of action of different plants. The terminal internodes of *Verbena ciliata* were available at the Desert Laboratory in March 1918, and sections of these with a tangential slice removed were about 1.8 mm. in thickness. Swellings at 18° to 20° C. were as shown in table 72.

TABLE 72.

Distilled water.....	<i>p. ct.</i> 7
Citric acid, 0.01 N.....	2.8
Sodium hydroxid, 0.01 M.....	7
Potassium chloride, hydrochloric acid, 0.01 M.....	4

The familiar relation much seen in young organs, by which the imbibition is least in the acid and most in water and alkaline solutions, is exhibited. Some interest attaches to this plant from the fact that its expressed and centrifuged juice has been found by Dr. H. A. Spoehr to aggregate and form a fairly firm jelly without concentration, an action probably due to the large proportion of pentosans present.

Forms of *Brodiaea* native to Tumamoc Hill start into activity late in February and by the end of the first week in March have formed new corms on the crowns of the older ones nearly 1 cm. in diameter, from the apices of which the long, slender leaves extend at a rapid rate. Halves of these corms arranged in the dishes under the auxographs gave swellings at 20° C. as shown in table 73.

TABLE 73.

	<i>p. d.</i>
Distilled water.....	5
Citric acid, 0.01 N.....	2.7
Sodium hydroxid, 0.01 M (not completed).....	2.2
Potassium chloride, hydrochloric acid, 0.01 M.....	2.5

The carbohydrate material in these organs is starch, and this and the products of its hydrolysis constitute the main components of the cells. The increases noted above are low, that in the alkaline solution being still in progress. The old corms form tapering extensions from the lower surface, which in the earlier stages are made up only of thin-walled cells, filled with the products of starch hydrolysis. These show swellings of 17 per cent in distilled water at the above temperature. Two other variations were tried to ascertain whether the young corm just formed, having swelling capacities as above, differed in hydration capacity from the older basal corms being emptied of their contents. This was accomplished by setting up a preparation of three plants in which the young corms were seated in place on the older corms. The average height of the preparation was 12 mm. and the increase in distilled water was 9.6 per cent at 20° C. Another set of preparations was made, in which older corms from which the young portion had been removed were immersed in water at similar temperatures. The increase in this case was 24 per cent, showing that these structures, in which the accumulated starch was in an advanced stage of hydrolysis, had an imbibition capacity much greater than that of the young corms. The fact must be taken into account that the young corms were firm and solid to the touch and were to be regarded as in a high state of imbibition, while the old corms had been partially emptied, but were capable of returning to the dimensions of their original turgid condition.

Tangential slices from the terminal internodes of asparagus tips, bought in the market in Tucson in March, were made to have a thickness of about 3 mm., and these gave swellings as shown in table 74.

TABLE 74.

	p. ct.
Distilled water.....	7
Citric acid, 0.01 N.....	4
Sodium hydroxid, 0.01 M.....	6.2
Potassium chloride, hydrochloric acid, 0.01 M. Immediate and marked shrinkage.	

The rapid and immediate shrinkage of these thin sections in the acidified salt solution was so striking that a second measurement was made, in which thicker sections swelled 4.4 per cent in the acidified salt solution within a few minutes and then began to shrink to the original dimensions and to smaller volume. Imbibition in the salt solution alone showed two phases: first, a very rapid swelling to a volume near the maximum capacity, then a slow increase which was still in progress 24 hours later and which at that time had brought the section to a thickness 10 per cent greater than the original. Such material in acids swells quickly and more gradually than in the combined solution, then slowly shrinks to the original dimensions and below. The presence of the salt accentuates the action of the acid, as it did also in the swelling of stems of *Verbena* in similar solutions, the increase in the acid being but 2.8 per cent, while it was 4 per cent in the combined solution, the explanation of which is probably to be sought in the combined effects of acids and bases (fig. 18).

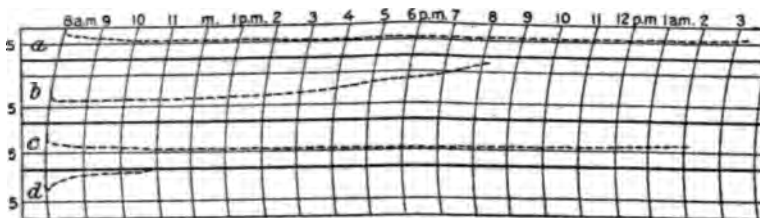

FIG. 18.—Swelling of tangential slices from tips of asparagus shoots at 14° to 17° C., × 20, on scale ruled to 5 mm. and 1-hour intervals. a, swelling of trio 3.8 mm. in thickness 7 per cent in water; b, swelling of trio 3.7 mm. in thickness 4 per cent in hundredth-normal citric acid; complete within a few minutes, followed by gradual shrinkage; c, swelling of trio of sections 6.2 per cent in sodium hydroxid with final shrinkage; d, slight swelling of trio of sections in hundredth-normal potassium chloride and hydrochloric acid and then rapid shrinkage.

Other aspects of the matter of permeability and swelling are offered by the reactions of young bean seeds which had not attained more than an eighth of their final volume and had a diameter of 2.8 mm. These were tested in a series parallel to the above and swelled as follows:

TABLE 75.

	p. ct.
Distilled water.....	8.2
Potassium nitrate, 0.01 M.....	9.9
Potassium nitrate, citric acid, 0.01 N.....	8.2
Citric acid, 0.01 N.....	5.4
Potassium hydroxid, 0.01 M.....	12.6

The proportions here were also those of an agar-albumin mixture, but the high swelling in the acidified salt was not shown. The beans

were intact, with an unbroken coat. It was probable, therefore, that osmosis may have played some part in the absorption in water and the solutions.

A second lot of the growing beans, which had an average diameter of 2.4 mm., was allowed to desiccate for 3 days, and when they had become hard and dry and were dead, the swelling tests were made with them, yielding the following results:

TABLE 76.

	<i>p. ct.</i>
Distilled water.....	29.2
Potassium nitrate, 0.01 M.....	22.9
Potassium nitrate, citric acid, 0.01 N.....	32.5
Citric acid, 0.01 N.....	29.2
Potassium nitrate, potassium hydroxid, 0.01 M.....	31.3
Potassium hydroxid, 0.01 M.....	15.8

It is evident that the activity of the vacuole is not the determining or dominating factor in the water-deficit or unsatisfied hydration capacity; if it were, the greatest swelling would have taken place in water. The action of the salt was not increased by the addition of acid in the swelling of the living cells, but such an effect was produced in the dried beans. The interferences were much less in the dried material, the swelling in acid being but little short of that in water, while it was relatively much less in the living material.

Young leaves of *Abronia latifolia* which had been allowed to wilt for two days while attached to stems in a ventilated room were cut into suitable strips free from the midrib and the larger veins in preparation for swelling tests. The spongy texture made it impossible to measure thickness with accuracy, but this was estimated as 1 mm. Increases in thickness were measured, as follows:

TABLE 77.

	<i>p. ct.</i>
Distilled water.....	40
Potassium nitrate, 0.01 M.....	80
Potassium nitrate, citric acid, 0.01 M.....	55
Citric acid, 0.01 N.....	50
Potassium nitrate, potassium hydroxid, 0.01 M.....	50
Potassium hydroxid, 0.01 M.....	60

Potassium nitrate gave a maximum swelling, a lesser one when acid was added with the salt, and still less swelling ensued when acid alone was used. The swelling in distilled water probably represents a normal imbibition total under the undisturbed conditions in the leaf. The partial neutralization of the acid by the addition of hydroxid gave a swelling determined by the acidified salts formed.

Half-grown succulent leaves of *Cakile* sp. were taken from the beach at Carmel, August 23, 1917. The total acidity, as determined by Professor H. M. Richards, was found to be equivalent to 0.30 c.c. hundredth-normal sodium hydroxid per gram of fresh material. The strips of leaf-blades, which were cut in such manner as not to include any of the main veins, had an average thickness of 1.2 mm. One lot

was immersed in solutions in a fresh condition, and others were allowed to lie on a window ledge for 24 hours, at the end of which time they were dead, shrunken, but limp, so that they remained in any shape into which they were bent or twisted. The swellings were as follows, on the basis of the original thickness:

TABLE 78.

	Living.	Dried.
	<i>p. ct.</i>	<i>p. ct.</i>
Distilled water.....	12.5	20.8
Potassium nitrate, 0.01 M.....	16.6	25
Potassium nitrate, citric acid, 0.01 N.....	16.6	4.2
Citric acid, 0.01 N.....	8.3	16.6
Potassium nitrate, potassium hydroxid, 0.01 M.....	12.5	37.5
Potassium hydroxid, 0.01 M.....	16.6	33.3

The swelling of the living tissues was greatest and was equal in salt, acidified salt, and hydroxid, while it was low in acid. The dried material swelled most in the salt, while it was least in acidified salt. Increases occurred in all the other solutions, the swelling in alkaline salt being three times as great as in the living material. It was evidently desirable to measure the water-relations of some simple plant structure which could be brought into the tests without anatomical injury and which would not suffer material and immediate injury by submersion. The small tubers of the potato seemed to meet these requirements.

A number of tubers of the second generation of a hybrid between a domesticated potato and *Solanum fendleri* of Arizona were available, and as these bodies were in a condition in which they were ready for planting and sprouting, tests were arranged to obtain the swelling measurements in various solutions. Trios of tubers 5 to 8 mm. in diameter were placed in the dishes after the total and average diameters had been ascertained. The first set swelled 7.5 per cent in 5 days in distilled water at 14° to 21° C., and the second increased the same proportion in hundredth-normal citric acid in 4 days. A series arranged to obtain the auxographic record as complete as possible was allowed to run for 11 days, at the end of which time the swelling in water amounted to 13 per cent, in hundredth-normal citric and hydrochloric acids 14 per cent, and less than 7 per cent in hydroxid, at temperatures between 14° and 20° C. identical for the lot. Actual shrinkage had not begun in any of the solutions and all solutions were renewed three or four times during the period.

A set of three with an average diameter of 8.3 mm. was placed in a solution of calcium chloride 3 N acidified to 0.01 N with hydrochloric acid. A steady shrinkage amounting to 3.4 per cent in 4 days began at once.

Later, when the tubers had begun to sprout, a set was arranged to obtain another series of tests, extended over a period of 22 days, with many renewals of the solutions. The swellings were as follows at 20° C:

TABLE 79.

	<i>p. ct.</i>
Distilled water .....	34.4
Citric acid, 0.01 N.....	24.4
Sodium hydroxid, 0.01 M.....	13.8
Potassium chloride, hydrochloric acid, 0.01 M.....	20

All of the tubers, with two exceptions, were turgid and firm at the end of the tests, even when extended over 22 days. Immersion in any of the solutions for a day or two usually prevented sprouting by killing the buds, although the remainder of the tuber kept alive. One of the three tubers in water in the last test sprouted in the dish at the end of a week and the excessive increase shown in this lot may be attributed in part to the action of the continued hydrolysis of starch as the growth of the etiolated stem proceeded.

Stiles and Jørgensen have made an extensive series of tests of the swelling of the potato, in which a wholly different technique was used. Plugs were cut from tubers, from which slices 2 mm. in thickness were taken, and these were immersed in solutions in bottles. Variations were taken by weight and the unavoidable difficulties of the method were dealt with in an exact manner. The interpretations of the action of the sections in the different solutions by Stiles and Jørgensen are all based on the assumption that the hydration is one based entirely on osmosis and that swelling ceases when the parenchymatous walls become permeable.<sup>1</sup>

The conditions presented by my experiments included the action of the external coat of the tuber, which is composed of non-living elements the permeability of which to water has been tested in a careful manner in certain structures by Denny. The fact that the swelling was greater in water than in any of the solutions might lead to the conclusion that absorption was largely by osmosis. Such an explanation can not be accepted as an adequate one, however. The cell colloids of the potato, being high in carbohydrates, would show the greatest swelling in water, and hydration would be retarded and limited by any contained acid or salt, except the amino compounds. In addition to this action of the living cells, the retarding action of the outer coat, with its possible differential action with respect to the acid, salt, and hydroxid, are to be taken into account.<sup>2</sup>

<sup>1</sup> Stiles, Walter, and Ingvar Jørgensen. Studies in permeability. The swelling of plant tissue in water and its relation to temperature and various dissolved substances. *Annals of Bot.*, 31: 415. 1917. See also Stiles and Jørgensen. Quantitative measurement of permeability. *Bot. Gazette*, 65: 526. 1918.

<sup>2</sup> Denny, F. E. Permeability of certain plant membranes to water. *Bot. Gazette*, 63: 373-397. 1917. Permeability of membranes as related to their composition. *Bot. Gazette*, 63: 468-485. 1917.

It is to be added that when the dried slices of the commercial preparation of potatoes known as "Anhydrous" were tested at 22° to 23° C., the sections, which were 1 to 1.1 mm. in thickness, showed a maximum swelling of 265 per cent in potassium hydroxid 0.01 M, 250 per cent in citric acid (0.01 N), and 200 per cent in acidified potassium chloride, at 0.01 N concentration, while the swelling in distilled water was 222 per cent. The relatively lessened swelling in distilled water, as compared with salts and acids, might be attributed to the elimination of the osmotic action of the semi-permeable membrane. The exact history of the preparation of the material is not available, however, and here, as in other dried material, the coagulatory effects of contained salts and acids in desiccation must be taken into account. This will become apparent from the results obtained from the swelling of dried apples made from machine-cut strips. Sections cut from these strips had an average thickness of 2.6 to 3.4 mm. and gave swelling increases as follows at 16° to 18° C.:

TABLE 80.

	<i>p. ct.</i>
Distilled water.....	72
Citric acid, 0.01 N.....	69
Sodium hydroxid 0.01 M.....	105
Calcium chloride, 3 M.....	123

The expected proportionate swellings in water, acids, and alkaline solutions are noted, but the great imbibition from the solution of calcium chloride which would afford an osmotic pressure of 68 atmospheres is a fact of extraordinary interest. An extension of the test was made in different concentrations of this salt, in which it was found that at 19° to 20° C., swellings of 82 and 95 per cent only were obtained in a solution of 0.01 M and in other tests of the original concentrated solution; 3 M gave an increase of 230 per cent on one trial and 106 per cent on another at the above temperatures. This maximum was obtained from sections 1 mm. in thickness, and it is suggested that they were in a state of undue compression. Similar sections swelled 180 per cent in a 2.7 M solution of potassium nitrate capable of exerting an osmotic pull of 84 atmospheres.<sup>1</sup> Thicker sections in the potassium solutions of this concentration swelled only 62 per cent and gave an expected greater swelling of 94 per cent in a 0.01 N solution. The maximum swelling in the concentrated calcium solution suggests that compounds of the calcium with the pectin may be formed of higher hydration value, which makes possible these unexpected imbibition reactions. Such swellings, however, have been found in the case of colloidal mixtures which simulate the action of the plant in concentrated solutions of potassium nitrate.

<sup>1</sup> MacDougal and Spoehr. The behavior of certain gels useful in the interpretation of the action of plants. *Science*, 45:484-488. 1916.



The cell-sap of *Echinocactus* grown at the Desert Laboratory has a low content of solid matter, and shows osmotic pressures of 3 to 5 atmospheres, calculated by cryoscopic methods. The acidity of the massive body is greatest in the external layers and decreases toward the center, and also shows daily variation which is greatest in the external layer. This is illustrated by the data in table 81, obtained by Mr. E. R. Long, in which *A* designates the external layer and *D* the innermost parenchyma, *B* and *C* being intermediate.<sup>1</sup>

TABLE 81.

Plant.	Weight.	Dates and hours.	Sample.	Afternoon.		Morning.	
				Dry wt.	Acidity.	Dry wt.	Acidity.
No. 27.	kg. 20	June 30-	A	11.9	0.376	10.0	0.342
		July 1...	B	10.7	.269	9.0	.278
		4 p. m.,	C	7.7	.154	7.5	.166
		8 a. m...	D	6.7	.143	7.1	.166

The freshly expressed juice of regions *C* and *D* of such a plant at midday caused sections of a biocolloid consisting of 5 parts agar, 3 parts mucilage of *Opuntia*, and 1 each of gelatine and bean protein to swell about 840 per cent at 20° C., while similar sections increased about 2,500 per cent in distilled water. Dried slices of the parenchymatous tissue similar to that from which the juice was expressed swelled 115 per cent in the juice, while they increased but 42 per cent in distilled water at the same temperature.

Some of the sap of *Echinocactus* caused dried slices of *Opuntia*, the swelling of which has been described in detail in Chapter VII, to swell 372 per cent at 20° C., which is to be compared with 550 per cent in distilled water. It is notable, however, that such dried sections of *Opuntia* increased 325 per cent in the sap expressed from living joints of the same kind, thus swelling less in its own sap than in that of *Echinocactus*. It seems probable that the possibilities of parasitism might be more profitably sought in these hydration relations rather than in the simpler osmotic coefficients to which the author attributed great importance in his original study of this matter.<sup>2</sup>

It is highly probable that any cell-mass would absorb water and swell in fresh sap from other cell-masses of the same kind in an equivalent condition. Kunkel placed spores of *Monilia sitophila* (Mont) in the sap of equivalent spores and obtained no plasmolytic effects and did not measure for swelling. When the sap was reduced to one-tenth

<sup>1</sup> Long, E. R. Acid accumulation and destruction in large succulents. *The Plant World*, 18: No. 10, 261. 1918.

<sup>2</sup> MacDougal and Cannon. The conditions of parasitism in plants. *Carnegie Inst. Wash. Pub. No. 129*, 1910. See also MacDougal, The beginnings and physical basis of parasitism. *The Plant World*, 20: p. 238. 1917.

of its volume by boiling, spores immersed in the concentrate plasmolyzed, as might be expected. The temperature implied would of course cause many changes in the constitution of the sap. The fresh juice was seen to cause plasmolysis in vegetative cells of *Spirogyra setiformis*.<sup>1</sup>

In any consideration of the general facts which are brought into a discussion of permeability in the experimental laboratory, one of the most disturbing features is the frequency with which results are encountered which can not be duplicated. The effects of phlorizin on the diffusion of sugar is an example of such a matter. Preparations of the fresh and turgid inner layers of onions prepared by Dr. H. A. Spoehr were found to contain an amount of sugar suitable for experimentation, and when such sections were placed in distilled water for a short period the amount of sugar extracted was fairly equivalent to that coming out of other sections placed in the solution of potassium carbonate and phlorizin (0.02 M) customarily employed in the experiments with this glucoside, and also to the amount of sugar which was found to diffuse out of sections placed in the potassium-carbonate solution alone. Wachter believed he had proved that the addition of a trace of potassium salt to water would prevent the diffusion of sugar from tissue of onions.<sup>2</sup>

Sections of the layers of onion bulbs were placed in distilled water and in solutions of phlorizin and potassium carbonate, to ascertain to what relative extent they might influence hydration. Trios of sections having an average thickness of about 2.3 mm. were prepared for measurement under the auxograph and a series of three preparations were swelled at 20° C. The set in water increased 1.5 per cent, that in the potassium carbonate 4.3 per cent, and the one in potassium carbonate and phlorizin 9 per cent, the maximum amount.

In the repetition of the above with other material the results were somewhat different. It was found that trios at 20° C. swelled 4 to 8 per cent in water, 7 to 11 per cent in the potassium-carbonate solutions, and between 5 and 6 per cent in the solution of phlorizin and potassium carbonate. Such results are indicative of an inequality of the material, but it is evident that not only does potassium carbonate not prevent the diffusion of sugar from the onion, but that a hydration of greater amount may occur in its presence than in water alone. Nothing could be determined as to the action of the phlorizin on plant colloids with relation to sugar.<sup>3</sup>

It has also been found impossible to bring the results of theoretical antagonisms of substances taken up by protoplasm into harmony with the results of hydrations made in the present connection, a matter

<sup>1</sup> Kunkel, Louis Otto. A study of the problem of water absorption. 23d Ann. Rep. Missouri Botanical Garden, pp. 26-40. 1912.

<sup>2</sup> Wachter, W. Untersuchungen über den Austritt von Zucker aus den Zellen der Speicherorgane von *Allium cepa* und *Beta vulgaris*. Jahrb. f. wiss. Bot., 41: 165. 1905.

<sup>3</sup> See Brooks, S. C. Permeability of cell-walls of *Allium*. Bot. Gas., 64:509. 1917.

which for the present may be ascribed in part to the fact that generalizations on permeability rest upon results obtained with a narrow range of material or under highly specialized conditions. It would seem allowable to assume, if antagonistic effects are to be attributed to the opposed action of two salts, that sections of living plants would show differentiating swelling capacities in balanced solutions and in their two components. The first trial of this matter was made with terminal internodes of *Mentha spicata*, which had attained about half of their final length and had an average diameter of 3 mm. The imbibition capacity of this plant in living and dried conditions has been described elsewhere in this paper. An estimation by Professor H. M. Richards made the approximate acidity of the "pure juice" such that 1 c.c. = 0.45 c.c. N/20 KOH, and that the total acidity of a gram of fresh material was equivalent to 0.64 c.c. N/20 KOH.

A few simple tests were planned which might furnish results having a bearing upon the present question. The neutralizing or balancing action of sodium and calcium being one of the commonest conjunctions, the action of these two elements in the form of chlorides were tried.<sup>1</sup>

The balanced solution, consisting of 100 parts of 0.375 M sodium chloride and 10 parts 0.195 M calcium chloride was used. Such a solution plasmolyzes cells of *Spirogyra*, but according to Osterhout's findings, the presence of two salts in the proportions given prevents either from passing the membrane. It would appear that Osterhout in later papers takes the position that the essential feature of antagonism between two substances consists in the fact that they produce opposed effects upon it.<sup>2</sup>

Sections of stems of *Mentha*, as described above, swelled about 0.075 mm. in distilled water, shrunk 1 mm. in the balanced solution, but came back to a volume slightly greater than the initial size when distilled water was run into the dish. The shrinkage in the solution of sodium chloride, 0.375 M, was very marked, dilution being followed by a resumption of the original volume. Similar effects were obtained with the solution calcium chloride.

The terminal parts of growing stems of an *Erigeron*, which were higher in acid than *Mentha*, were next tested. The sections had a diameter of about 3.7 mm. and included a length of 5 to 7 mm. of the stem. The balanced solution and its constituents were diluted to one-thirtieth of the above concentration to avoid shrinkage by plasmolysis. The swelling in distilled water (average of 3 sections by auxographic method) was 0.2 mm.; in the balanced solution, 0.15 mm.; in sodium chloride (6 sections), 0.2 mm.; and in calcium chloride (6 sections), 0.15 mm. These minute swellings progressed for a

<sup>1</sup> Osterhout, W. J. V. The permeability of living cells to salts in pure and balanced solutions. *Science*, 34: 187-189. 1911.

<sup>2</sup> Osterhout, W. J. V. Nature of antagonism. *Science*, 41: 255-256. 1915.

period of 9 or 10 hours (inclusive of the action of distilled water). The sections then slowly shrunk at rates which would carry them back to original volume in a similar period. The swelling in the balanced solution was equivalent to the effect of its calcium, while the sodium alone gave a greater swelling than the balanced solution. The swelling in this salt was as great as in distilled water.

Sections of young joints of *Opuntia* have been subjected to a wide variety of tests, and a set of these was placed under conditions similar to those noted for *Erigeron*. The swelling in distilled water was 7.1 per cent, dilute balanced solution 8.7 per cent, sodium chloride 7.2 and 8.2 per cent, and in calcium chloride 7.7 and 8.8 per cent. The small differences in the proportionate swelling do not appear to have any bearing on possible antagonisms.

The masses of tissue used in the above tests were complex as to composition and doubtless already contained some of the salts of the balanced pair. It seemed important to test the effect of antagonistic salts on a biocolloid inclusive of bean protein, and a simpler one in which agar was combined with glyocoll. The results of the measurements were as shown in table 82.

TABLE 82.

	Agar 90 parts, bean protein 10 parts, 0.23 mm. in thickness.		Agar 90 parts, glyocoll 10 parts, 15 mm. in thickness.	
	p. ct.	p. ct.	p. ct.	p. ct.
Distilled water.....	569.6	.....	1,133.3	.....
Balanced solution.....	195.6	239.1	466.6	533.3
Calcium chloride, 0.195 M..	195.6	.....	400	.....
Sodium chloride, 0.375 M...	228.3	.....	533.3	.....
Sodium hydroxid, 0.01 M..	195.6	.....	333.3	.....

The amount of imbibition in the balanced solution in both colloids was less than half that in distilled water, and was not much different from that in the sodium chloride. The amount of imbibition in the calcium component used separately was less than that in the sodium chloride alone. No aspect of the above experimentation seems to promise anything of importance concerning the nature of the external layer of the cell, differential action of which to solutions of various kinds is so largely a matter of assumption. In fact, but little of the evidence obtained by the extended experiments described in this volume requires such a conception for its explanation, a conclusion previously set forth very clearly by Kunkel after an experimental examination of some features of the reactions of cells supposedly associated with semi-permeable membranes.<sup>1</sup>

<sup>1</sup>Kunkel, Louis Otto. A study of the problem of water absorption. 23d Ann. Report, Missouri Botanical Garden, pp. 26-40. 1912.

The swelling of dried sections is clearly under conditions exclusive of the action of a semi-permeable membrane, except in so far as the cell-walls may show such properties. If desiccation resulted in simple loss of water such as that which ensues in an unsalted plate of biocolloids, the action of living and dried material might be expected to be identical. The presence of salts and acids, however, causes some irreversible changes, and the relative swelling of dried sections in various solutions is different from that of a series obtained from the use of living cell-masses. That the cell does act as an osmotic machine is established beyond all question. That it is an enormously complex system of osmotic sacs is well established. That the differential action of the specialized layers formed at all phase boundaries can be made to account for the entire relations of the protoplast is more than doubtful. While all hydration in the broadest sense, including osmotic action, ultimately depends upon molecular affinity, it is evident that the conception of the semi-permeable sac does not offer a suite of possibilities which may account for the range of action of the protoplast.

A second proposal is that which has been most clearly outlined by Dr. E. E. Free, based upon the general acceptance of specialization of colloidal conditions in the external layer of the protoplast, but explains its action upon changes in the relations of the colloidal phases in it.<sup>1</sup>

Shrinkage of such a cell would follow a change in the dispersion or phase relations of the external layer, and might be accompanied by the solvation or passage out of the cell of substances which would reduce its water-holding capacity still further. The explanation based on osmosis might account for the escape of the free liquid of the vacuoles, or from synergetic cavities, but some mechanism such as that suggested by Free is necessary to account for the lessening of the amount of water held by the cell colloids.

Some further evidence on the matter of extraction of substances from colloidal masses and the action of contained substances on desiccating colloids remains to be considered. The facts which seem to warrant the prolongation of the discussion were obtained by a comparison of the results of swelling of living and dried sections, with determinations of their acidity, measurements of substances extracted, and measurements of repeated swellings of the same material.

These treatments as applied to median slices of maturing joints of *Opuntia discata* grown at Carmel gave measurements at 18° C. as shown in table 83.

The second swelling of dried sections which had been once swelled (extracted) indicate that some material of high hydration capacity had been dissolved out, as the sections which had been simply dried swelled 25 times as much in potassium nitrate. Material which was dried directly without extraction did not undergo any lessened hydration

<sup>1</sup> Free, E. E. A colloidal hypothesis of protoplasmic permeability. *Plant World*, 21:141. 1918.

capacity by swelling, as it swelled a second time to the same amplitude, except in the acid solution.

TABLE 83.

Opuntia discata.	Living median slices.	Same sections dried. Swelling calculated on basis of original thickness.	Dried median slices not previously treated.	
			First swelling.	Second swelling after drying.
	<i>p. ct.</i>	<i>p. ct.</i>	<i>p. ct.</i>	<i>p. ct.</i>
Distilled water.....	11.4	17.5	430	430
Citric acid, 0.01 N.....	6.4	26.4	357	250
Potassium hydroxid, 0.01 M.	6.6	24.5	315	352
Potassium nitrate, 0.01 M..	9.2	22.4	541	541

Swelling of fresh material implies bursting of cells by combined imbibition and absorption and the consequent escape of the mucilages which would not occur in the hydration of dried sections, and these would consequently, in reswelling, regain their original dimensions, or repeat the first swelling.<sup>1</sup>

That this action depends on the condition of the cell-masses was demonstrated by the fact that another series of sections of the same plant which included the chlorophyllose layer and the epidermis did not show such duplication of results on the second swelling. The increases at 16° to 18° C. were as shown in table 84.

It would be unsafe to assume that such a result is associated only with a chlorophyll-bearing tissue, as median slices of a second opuntia with a smaller proportion of mucilage gave similar swellings at 16° C., as shown in table 85.

The lessened swelling in this case can not be attributed to the escape of pentosans from bursting cells, and attention naturally is directed to the readily diffusible amino-acids, the presence of which facilitates hydration in a remarkable way.

The swelling of the pentosan agar, which has been used so widely in the imbibition measurements in connection with growth, would be

TABLE 84.

Opuntia discata, median slices.	First swelling.	Second swelling.
	<i>p. ct.</i>	<i>p. ct.</i>
Distilled water.....	225	100
Citric acid, 0.01 N.....	225	107
Sodium hydroxid, 0.01 M...	281	87.5
Potassium hydroxid, 0.01 M.	287.5	137.5

TABLE 85.

Opuntia discata, median slices.	After first drying.	After second drying.
	<i>p. ct.</i>	<i>p. ct.</i>
Distilled water.....	361	42
Citric acid, 0.01 N.....	306	56
Potassium hydroxid, 0.01 M.	250	100
Potassium nitrate, 0.01 M..	325	75

<sup>1</sup> MacDougal and Spoehr. The solution and fixation accompanying swelling and drying of biocolloids and plant tissues. Plant World, 22: June 1919.

accompanied by the solution or dispersion of material from the external part of the sections and by the diffusion of whatever salts or acids might be present in the interior of the mass. Sections 0.25 mm. in thickness swelled 2,420 per cent in water, and material equivalent to 200 similar sections, weighing 1.6731 g., placed in water for the same length of time, lost 0.2570 g., or 15 per cent of the total. A similar test of sections composed of 8 parts agar and 2 parts gelatine showed a swelling of 1,684 per cent, with a loss of 18 per cent of the original weight by dispersion or solution in the water.

Sections of *Opuntia* swelled in water for 24 hours at 16° to 18° C. lost 7 per cent of the average total dry weight of similar sections. As much of the dry weight is insoluble cell-wall, it is to be seen that the actual percentage of soluble or diffusible material extracted was large, a fact which would readily account for the lessened reswelling of sections.

A single effort was made to ascertain to what extent the acids are extracted in the hydration of living cell-masses of *Opuntia* and in dried sections of the same. Determinations by Professor H. M. Richards of the acidity of the water in which fresh slices of the *Opuntia* were swelled showed that this might be expressed as follows: 10 c. c. solution from dish in which set of fresh sections were swelled in water = 0.44 N/20 KOH.

Dried slices of the above material, when swelled in water 24 hours, gave a solution the acidity of which might be expressed as 10 c. c. of solution = 0.10 N/20 KOH.

When such sections were immersed in citric acid 0.01 N, the strength of the solution was increased so that at the end of 24 hours the acidity was expressible as 10 c. c. of solution = 2.25 N/20 KOH.<sup>1</sup>

The extraction of acid from the fresh sections in water is marked and is much greater in the acid solution. This action in setting free the amino-acids would cause a loss in hydration capacity which would become apparent on reswelling.

The chief interest in the present work is centered in the hydration of protoplasm associated with growth. The development of embryonic cells from the stage of a highly granular, dense colloidal mass with a large nucleus to maturity is characterized by the migration of proteinaceous material from the nucleus into the remainder of the mass; by the formation of synergetic cavities, including those designated as vacuoles; and by a constantly varying metabolism which results in continuous alterations in the composition of the vacuolar fluids, and in the composition and hydration capacity of the protoplasm.<sup>2</sup>

The peripheral part of the colloidal mass is probably of greater density than the interior, and it is the behavior of this layer which

<sup>1</sup> MacDougal, Richards, and Spoehr. The basis of succulence in plants. Bot. Gaz., 67: 405. 1919.

<sup>2</sup> See Thoday, D. On turgescence and the absorption of water by the cells of plants. The New Phytologist, 17: 108. 1918.

gives rise to most of the phenomena known as permeability and osmosis. The external layer, as well as the entire colloidal mass, reacts to solutions in a manner determined by its composition and its history, especially with respect to the salts which have come into the cell since its formation, and particularly to the salts which may be dissolved in the water in which the cell is immersed. The absorption of such salts alters the capacity of the colloids in various ways. In the case of the alkaline solutions, it has already been pointed out that nearly all plant tissues show a long-continued swelling which may be reasonably ascribed to the formation of a salt between the sugar and the hydroxide, which salt has a greater capacity for hydration than the carbohydrates alone.

Acids decrease the hydration capacity of agar and of the pentosans which enter into the composition of certain types of plant cells, of which the tissues of the potato would be a good example.

The death of cell-masses by desiccation probably produces less disarrangement of the material of the cell than any other method of killing, and not only the colloidal mass, but its external layer, probably retains its condition with respect to phases with but little serious disturbance. The only positive movement which might be recognized as of importance in connection with the point now being discussed would be that as drying-out proceeds the salts and acids of the mass would pass toward the periphery and might accumulate at that place, although it could by no means be assumed that such action would result in a uniform deposition in the membrane. The hydration of such dried material would take place as in other dead material, being largely by means of imbibition and adsorption, with osmosis by the action of vacuolar material almost eliminated. The records of many measurements of dried plants, of which fresh and living portions have been tested, as described in this chapter, are meant to be explanatory and illustrative, but they show conclusively that any serious development of our conceptions of the water-relations of cell-masses must be based upon and take seriously into consideration the hydration processes of the protoplasmic colloids.

Colloids are never at rest, yet it is possible to secure combinations of conditions in mixtures in which hydration, for example, is all but complete. Protoplasm, however, is the seat of complex transformations and is the medium of such diverse diffusion movements that ideally it is never in a condition of satisfied hydration. The amounts which it may take up from different solutions and under various conditions previously described may, on proper analysis, serve to show the nature of the protoplasmic colloid with respect to its principal components. The determination of the index of unsatisfied hydration, or the water deficit, is an indispensable feature of any serious effort to analyze growth into its physical components.



## IX. TEMPERATURE AND THE HYDRATION AND GROWTH OF COLLOIDS AND OF CELL-MASSSES.

Living material is a colloidal mass consisting of a mixture of colloids, the most important components of which are carbohydrates and proteins or protein derivatives. Salts of sodium, potassium, and magnesium in various combinations are dissolved in the system. The denser portions of the protoplasm, including all of the continuing structures, or those of morphological rank, have the properties of an elastic gel with the general structure of a fine sponge or a honeycomb with irregularly broken or incomplete walls. The materials which make up this fairly continuous structure are also in a disperse or liquid condition in the cavities and may even fill large synergetic spaces in the general structure.

The essential feature of growth consists in the accretion of material entering into this colloidal structure, its hydration, and its arrangement into additional structures or portions of honeycomb. This may be pictured as taking place by an initial increased dispersion or enlargement of the colloidal network to a point where new masses of gel would be formed in the liquid phase of the existing mesh. Considering living material as an intimate mixture of minute particles of its main colloidal components (and the scanty evidence on this matter is to the effect that the carbohydrates and proteins do not diffuse into each other), it is on this basis to be assumed that the new material would accrue to these separately and in a characteristic and differentiated manner.

Aggregations of the introduced material might also take place in synergetic cavities, with opportunity for the development of specialized structures. The absorption and diffusion of material in liquid form and its diffusion into the colloidal mass would in all cases be the initial step in growth. The consequent swelling with all of its accompaniments and consequences in cell-masses of plants and in my biocolloidal mixtures has been found to depend upon the character and the proportion of the proteins or protein derivatives in the colloid, the proportion of the pentosans, and the amount of salts present. In addition to these features, which change but slowly, the active metabolism of the growing cell includes respiration in which substances such as sugars may be adsorbed on surfaces of aggregates of enzymes which catalyze them, acids occurring at certain stages of the resultant reactions. Acidity in a growing cactus, for example, may vary between a value of 0.1 N malic acid and one-twentieth of this amount during the course of a daylight period, causing very marked changes in the imbibition and absorption of the cell-colloids.

The exposure of a growing or swelling colloid to different temperatures has several effects: First, the rate of absorption and diffusion of

water is modified, being generally accelerated by a rise within the range of ordinary temperatures at which plants grow. Next, adsorption is affected in a contrary manner, but the complex series of reactions associated with respiration are speeded up, with consequences far too complex to be characterized here. The first step, that of absorption and diffusion, would be far simpler, as the rate of acceleration here would be nearly identical with that of the diffusion of the same material in water.

A determination of the effect which temperature might have on growth necessarily takes into account, first, the fundamental increase which might accrue from simple absorption under various conditions. In recognition of this fact, it was arranged to carry on swellings of some of the biocolloids in order to gain some appreciation of the imbibition factor in growth. Sections 0.2 mm. in thickness of plates of agar 90 parts, bean protein 10 parts, and culture salts 0.85 per cent were swelled at 15° C. and at 22° C. The rate of swelling may be appreciated by a consideration of the total amounts at the end of 4 hours, 8 hours, and at the end of the test (fig. 19).

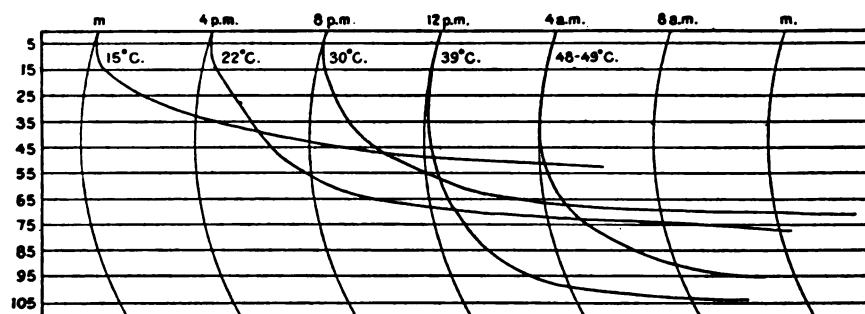

FIG. 19.—Tracing of auxographic record of swelling of dried plates 0.2 mm. in thickness of a salted "biocolloid" consisting of 9 parts of agar, 1 part bean protein, and 0.015 part nutritive salts. Increase is denoted by downward movement of the pen, amplified 20 times. The initial rate and continuance of the swelling at various temperatures may be compared.

TABLE 86.—Swelling of mixture of agar, bean protein, and cultures in distilled water.

	Swellings, per cent.		Averages.
4 hours (15° C.).....	800	875	838
8 hours (15° C.).....	1,150	1,075	1,113
22 hours (15° C.).....	1,325	1,325	1,325
4 hours (22° C.).....	1,325	1,450	1,388
8 hours (22° C.).....	1,400	1,700	1,550
22 hours (22° C.).....	1,900	1,900	1,900

The hydration during the first 4 hours includes any process of chemical union of water with the colloidal material by which water in definite proportions enters into the molecular aggregates. The greater part of this action probably takes place within the first half

hour of immersion, with consequent great rapidity of swelling. It is not possible to separate this action from adsorption, which follows more slowly, but if the first 4-hour period be considered, it is to be seen that the total rises from about 9 to 14, with a change from 15° to 22° C. at which the immersion was made. If the first 8 hours is considered, the hydration as expressed by the total swelling is as 11 to 16 at the two temperatures and as 13 to 19 for the entire period of hydration, a ratio which includes the accelerating effects of a rise in temperature both on the initial chemical action and the continued absorption.<sup>1</sup>

A biocolloid without salts consisting of 9 parts agar and 1 part oat protein was now tested for comparison, with results shown in table 87.

TABLE 87.

	Swellings, per cent.		Averages.
4 hours (15° C.).....	1,111	1,222	1,167
8 hours (15° C.).....	1,417	1,500	1,459
23 hours, final(15° C.)..	1,722	1,866	1,794
4 hours (23° C.).....	1,278	1,333	1,306
8 hours (23° C.).....	1,944	1,861	1,903
23 hours (23° C.).....	2,528	2,444	2,486

The swelling during the initial period of this salt-free mixture is actually greater than that of the first mixture, but is affected in far less degree by the rise in temperature, the ratio at 15° C. and at 23° C. being as 12 to 13. The difference, if the 8-hour period is considered,

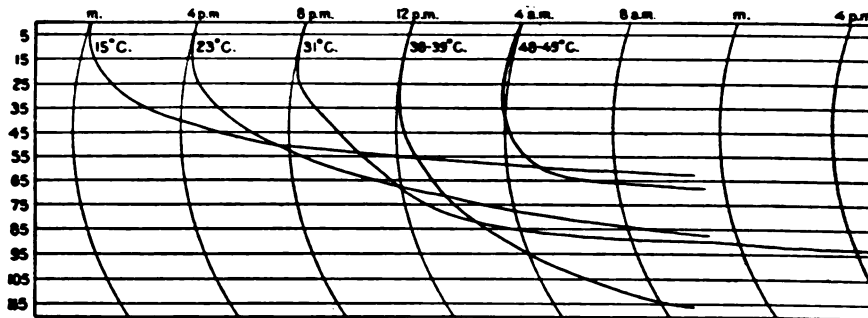

FIG. 20.—Tracing of auxographic records of swelling of plates 0.18 mm. in thickness, consisting of 9 parts agar and 1 part oat protein, a "biocolloid" with very high hydration capacity. The 5 mm. and 4-hour intervals of the record sheet are shown. Increase is denoted by the downward movement of the pen, which amplifies the actual swelling 20 times. The variation in initial and following rates and time necessary for hydration are shown.

was as 16 to 10, and for the 23-hour period, as 18 to 25. It is suggested that the chemical action during the beginning stages of swelling is far less important than in the salted mixture and that the entire set of reactions is one in which absorption and hydrolysis play the determin-

<sup>1</sup> MacDougal. The relation of growth and swelling of plants and biocolloids to temperature. Proc. Soc. Exper. Biol. and Med., 15:43. 1917.

ing rôle. A much more pronounced effect, however, was secured at the temperature of 31° C. (fig. 20).

Plates of agar 90 and oat protein 10 parts which were 0.16 mm. in thickness were swelled at a temperature of 31° C. at intervals of 2 hours or more, with the results given in table 88.

TABLE 88.

	Swellings, per cent.		Averages.
4 hours.....	2,031	2,312	2,172
8 hours.....	2,556	2,968	2,763
20 hours.....	2,906	3,250	3,078

The acceleration, as expressed by the total during the first 4 hours, was as 13 to 22 in the rise from 23° C. to 31° C., as 19 to 28 when the first 8 hours is considered, and as 25 to 38 when the entire swelling is taken into account. Raising the temperature to 39° C. gave swellings as shown in table 89.

TABLE 89.

Agar 90, oat protein 10.			
	Swellings.		Average.
	p. ct.	p. ct.	p. ct.
4 hours.....	2,361	2,722	2,542
8 hours.....	2,555	3,166	2,861
12 hours.....	2,611	3,222	2,917

TABLE 90.

Agar 90, oat protein 10.	
	Swellings.
	p. ct.
4 hours....	2,555
8 hours....	2,833
10 hours....	2,888

The acceleration accompanying this rise of 8° C. was followed by an increase which was as 22 to 25 during the first 4 hours, 28 to 29 during the second 8 hours, and the hydration for the entire period was actually less at this higher temperature. That the hydration passed beyond the limits of acceleration and of total water-holding capacity in this temperature region was denoted by the fact that swellings at 46° to 47° C. were as given in table 90.

TABLE 91.

	Swellings.		Averages.
4 hours.....	1,444	1,500	1,472
8 hours.....	1,666	1,805	1,735
20 hours.....	2,083	1,972	2,022

It is to be seen that while the final capacity for swelling at 15° C. had not been reached in 20 to 22 hours, it was practically complete at 39° C. in 12 hours, as the continuance of the measurement would

have detected a very small expansion, while satisfaction was nearly complete in 8 hours at 46° to 47° C.

We may now profitably turn to an extension of the reactions of the salted colloids (see p. 111). Sections of agar, bean protein, and nutrient salts 0.18 mm. in thickness gave the expansions shown in table 91 at 31° C.

The temperature series was taken another step by raising the air in the chamber to 42° C., at which point the liquid in the dishes showed 38° to 39° C., being cooled by evaporation to this point. The measurements are given in table 92.

TABLE 92.

Agar 90, bean protein 10, nutrients salts 0.85.			
	<i>Swellings</i>		<i>Averages.</i>
	<i>p. ct.</i>	<i>p. ct.</i>	<i>p. ct.</i>
4 hours.....	2,381	2,611	2,486
8 hours.....	2,638	2,833	2,736
12 hours.....	2,693	2,888	2,791

The increase of the temperature of the air in the chamber to 52° C. gave a temperature of 46° to 47° C. to water in the dishes. The swellings at 46° to 47° C. are shown in table 93.

TABLE 93.

Agar 90, bean protein 10, nutrient salts 0.85.			
	<i>Swellings.</i>		<i>Averages.</i>
	<i>p. ct.</i>	<i>p. ct.</i>	<i>p. ct.</i>
4 hours.....	2,000	2,305	2,153
8 hours.....	2,194	2,500	2,347
10 hours.....	1,111	2,500	2,361

A review of the action of the salted mixture shows a very slight acceleration by the rise in temperature from 22° C. to 31° C. and also a total but slightly increased above that of the lower temperature. The next step, from 31° to 39° C., however, was one marked by a distinct acceleration, the rates during the first 4 hours being as 15 to 25, during the first 8 hours as 17 to 27, and the final total at the lower temperature at 20 hours was as 20 to 28 at the higher temperature at the end of 12 hours.

The absorption of water fell off at temperatures above 39° C., which may be regarded as in the region of the optimum or maximum water-holding capacity, which is somewhat lower than that of the salt-free mixture. Many repetitions of the tests would be necessary before the matter of the failure to show expected increase of hydration between 23° and 31° C. was accepted as a reality. The measurements in ques-

tion, however, suggest that even in hydrating colloids, in which metabolism is not in progress, abrupt modifications may occur by the conjunction or disjunction of two important reactions of the constellation present.

The chamber in which these tests were made was under ground, with earthen and board walls, and was reached through an entrance chamber. Electric heaters were used. The chamber was 2.7 by 2 by 2.2 meters and it was necessary to enter and work in it when making the tests. The air was stirred by a fan and a mercurial thermometer suspended from the ceiling showed air temperatures several degrees above that of the water in the dishes. Thus, in the preceding test, the observer was in a humid atmosphere at 55° C. (131° F.) when the readings of the swellings were 48° to 49° C.

The compilation of averages (table 94) affords a ready means of comprehension of the essential features of the entire series.

TABLE 94.

	4 hours.	8 hours.	20 to 22 hours.
<b>Agar 90, bean protein 10, culture salts 0.85:</b>	<i>p. ct.</i>	<i>p. ct.</i>	<i>p. ct.</i>
15 to 16° C., 0.20 mm.	888	1,113	1,325
21 to 23° C., 0.20 mm.	1,388	1,550	1,900
30 to 31° C., 0.18 mm.	1,472	1,735	2,022
39° C., 0.18 mm.	2,486	2,736	2,791 (12 hours).
46 to 37° C., 0.18 mm.	2,163	2,347	2,361 (10 hours).
48 to 49° C., 0.18 mm.	2,361	2,514	No swelling after 8 hours.
<b>Agar 90, oat protein 10:</b>			
15 to 16° C., 0.18 mm.	1,167	1,459	1,794
22 to 23° C., 0.16 mm.	1,388	1,550	1,900
30 to 31° C., 0.16 mm.	2,172	2,763	3,078
38 to 39° C., 0.18 mm.	2,541	2,861	2,917 (12 hours).
46 to 47° C., 0.18 mm.	2,555	2,833	2,889 (10 hours).
48 to 49° C., 0.16 mm.	1,906	2,031	No swelling after 8 hours.

A series of swellings of agar sections 0.18 mm. in thickness, made at the same time, affords valuable data for comparison with the increases of the complex biocolloids (table 95).

The hydration reactions of the agar are not so positive and uniform as those of the more complete systems. Increase by absorption had not reached a positive final in 24 hours at the lowest temperature. A similar stage of satisfaction was evident in half this time at about 40° C. and in 8 hours at 49° C. The rate of swelling is graphically illustrated in figure 21.

The maximum or "optimum" of swelling of such agar plates occurs at some temperature near 40° C. Initial rate and total increase are greatest at this point. The maximum swelling of the agar, bean pro-

tein, and salt mixture lies below 46° C. and is probably above 40° C., as both rate and total capacity become uncertain at 46° C. and above.

The agar-oat protein mixture has a higher initial capacity at 46° to 47° C., but does not appear to absorb as much water as it did at

TABLE 95.

	Swelling of agar.						
	4 hours.	8 hours.	10 hours.	12 hours.	16 hours.	20 hours.	24 hours.
18 to 21° C.....	875	961	.....	1,069	1,111	.....	1,153
	806	889	.....	1,000	1,054	.....	1,068
	944	1,063	.....	1,139	1,168	.....	1,222
27° C.....	1,000	1,083	.....	1,278	1,333	.....	.....
	1,056	1,167	.....	1,208	1,250	.....	.....
29 to 31° C.....	1,292	1,389	.....	1,417	1,444	.....	.....
39 to 41° C.....	1,472	1,556	.....	1,583	.....	.....	.....
	1,750	1,778	.....	1,833	.....	.....	.....
40 to 41° C.....	1,611	1,667	.....	.....	.....	1,708	.....
46 to 47° C.....	1,306	1,389	1,416	.....	.....	.....	.....
48 to 49° C.....	1,333	1,417	.....	.....	.....	.....	.....
Averages.							
18 to 21° C.....	875	978	.....	1,069	1,111	.....	1,153
27° C.....	1,028	1,125	.....	1,244	1,222	.....	.....
39 to 41° C.....	1,611	1,667	.....	1,708	.....	.....	.....
46 to 49° C.....	1,320	1,403	1,416	.....	.....	.....	.....

a temperature a few degrees lower. The probable error at the highest temperatures is great, however, and conclusions as to a separation of initial rate and final capacity should be made with caution.<sup>1</sup>

The relation of temperature to swelling of agar and of these colloidal mixtures is of interest because of the fact that they lie within the range of activities of plants. The greater number of seed-forming plants

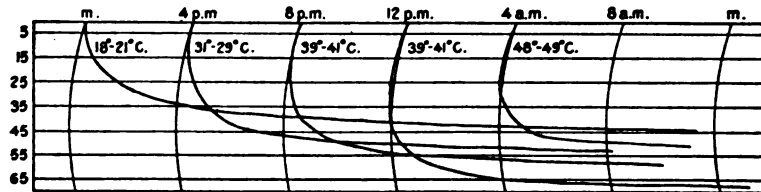

FIG. 21.—Tracing of auxographic records showing swelling of plates of agar 0.18 mm. in thickness at various temperatures. The 5 mm. and 4-hour intervals of the record-slip are shown. Increase is denoted by the downward movement of the pen, which amplifies the actual increase 20 times. The initial and following rates are well illustrated.

do not endure air-temperatures of above 45° or 46° C. The temperature of the stems or growing-zones in such exposures can not be calculated from such data unless sunlight exposure is known. Actual temperatures of the tissues have been taken by a few observers, from

<sup>1</sup> See Freundlich, H. *Kapillarchemie*, 1909, pp. 504-511, and references given also Ostwald, W., *Tranal.* by M. H. Fischer. An introduction to theoretical and applied colloid chemistry, pp. 84-92. 1909.

which it is seen that the cells may at times have a temperature  $20^{\circ}\text{C}.$ <sup>1</sup> higher than the air. The previous maximum record is that of  $51.5^{\circ}\text{C}.$  for *Euphorbia virosa*, obtained by Pearson in South Africa in 1913.<sup>2</sup>

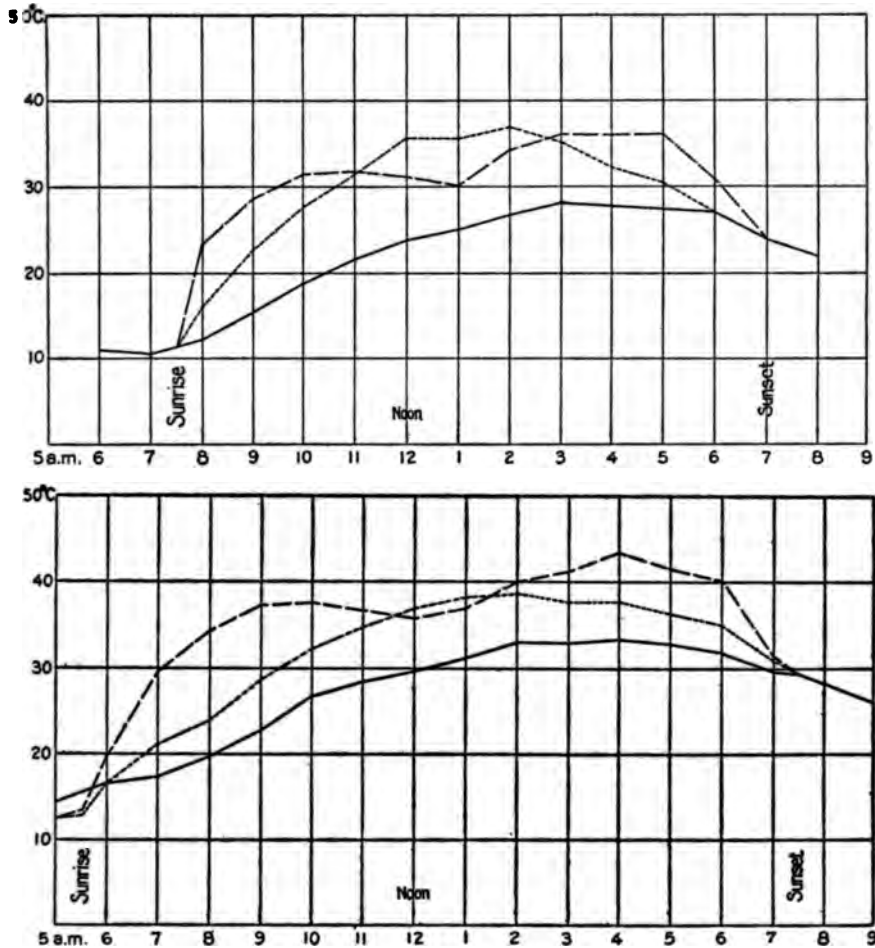

FIG. 22.—Temperatures of joints of *Opuntia* in the open at Desert Laboratory on a day in March and a day in June 1916. The solid line denotes air temperatures, the dotted line the temperature of a joint in an east-and-west position with the faces north and south. The broken line gives the course of the temperature of a joint with its faces east and west, and showing a drop in temperature when the margin is toward the sun at midday. The upper part of the figure is compiled from the records of March 9, 1916. The lower set of lines is compiled from the records for June 2, 1916. Redrawn after diagram furnished by Dr. J. M. McGe.

A proper interpretation of the reactions of the plants used as experimental material in the present work might be made only when the ordinary exposures were measured, and this was undertaken at the request

<sup>1</sup>Askenasy, E. Ueber die Temperatur, welche Pflanzen im Sonnenlicht annehmen. *Bot. Zeitung*, 33: 441-442. 1875. See also U'sprung, A. Die physikalischen Eigenschaften der Laubblätter. *Bibliotheca Botanica*, 12: (Heft 60), 68. 1903-4.

<sup>2</sup>Pearson, H. H. W. Observations on the internal temperatures of *Euphorbia virosa* and *Aloe dichotoma*. *Annals of the Bolus Herbarium*, vol. 1, part 2. Nov. 1914.



of the author by Dr. J. M. McGee at the Desert Laboratory in 1916. Mature joints of *Opuntia* were arranged vertically in two sets, one with all in a meridional position and the other in an east-and-west position, so that the edges only were exposed to the rising and setting sun. Sets of two each were observed for short periods, in which the joints were kept moving at a rate which kept the edges or the full surface exposed to the direct rays of the sun during the entire day.<sup>1</sup>

The course of the temperature on two days is shown in figure 22. The joints which were in a fixed north-and-south position showed a dry weight slightly in excess of those which were in an east-and-west position. The temperature of the plants facing north and south rose steadily until about 2 p. m., then began to decline, falling to a point below that of the air soon after sunset. Joints facing east and west rose in temperature until about 11 a. m., then a slight drop took place until the sun shone on the western face of the joint, at which time it began to rise, reaching a maximum at 4 p. m. It is evident that the position of these members may through the temperature-relation modify the rates of growth or of hydration. During midsummer the mature joints may attain daily temperatures of 53° to 55° C. The data obtained by the author show that such delicate members as etiolated shoots, as well as green joints, may endure temperature of 51.5° C. and to show enlargement a degree or two below that point. (See page 135.)

The newly developed method for determining temperatures of leaves by a thermo-electrical method developed by Mrs. E. B. Shreve at the Desert Laboratory promises to be of great use in the accurate determination of this important condition in plants.<sup>2</sup>

A series of measurements were made with joints of *Opuntia* grown at the Coastal Laboratory, in which the degree of hydration was high, so that the total possible swelling in fresh material was small, although, as may be seen by reference to page 132, the increase of dried sections was indicative of the presence of a carbohydrate-protein complex of a high hydration coefficient.

Two recently matured joints grown in the open, and subjected to air-temperatures of 16° to 22° C., were taken for each test. The sections at the highest temperature had an average thickness of 9.4 mm. Those used in the tests at 24° to 25° C. were about 12 mm. in thickness, and the third lot had an average thickness of about the same.

Trios were placed in glass dishes containing about 25 c.c. of liquid, the total volume of the sections being about 3 c.c. Temperatures were taken by mercurial thermometers, the bulbs of which were thrust into the dishes from time to time. The testing-chamber was not illumi-

<sup>1</sup> McGee, J. M. The effect of position on the temperature and dry weight of joints of *Opuntia*. Rep. Dept. Bot. Research, Year Book No. 15 for 1916, Carnegie Inst. Wash. 1917.

<sup>2</sup> Shreve, E. B. A thermo-electrical method for the determination of leaf temperature. *Plant World*, 22: 100. 1919.

nated, except during the few minutes when examinations were being made. The swelling measurements are given in table 96.

TABLE 96.

	18 to 20° C.		24 to 26° C.		44 to 45° C.	
	<i>p. ct.</i>	<i>hours.</i>	<i>p. ct.</i>	<i>hours.</i>	<i>p. ct.</i>	<i>hours.</i>
Distilled water.....	11.8	42	13	40	7	5
Potassium nitrate, 0.01 M.	14	42	14.4	42	8.4	7
Potassium nitrate, citric acid, 0.01 N.....	8.8	32	13.2	42	4.9	25
Citric acid, 0.01 N.....	7.3	20	7.8	14	4.9	2
Potassium hydroxid, 0.01M	12.2	44	13.2	42	5.8	4

The data given in table 95 yield a number of exceedingly interesting suggestions as to the absorption and incorporation of water by living sections in the presence of various substances. The time in which saturation takes place varies widely in the range of temperatures which is a normal one for this plant. Satisfaction of the water capacity of the sections requires 42 hours at the lowest temperature and but 5 hours at the highest in distilled water. The change is from 42 hours to 7 in potassium nitrate and from 32 to 25 in the acidified salt and from 20 to 2 in the acid. The living material already contains a normal supply of both substances and immersion in them involves an increase in their action. The action of the sodium hydroxid is, as has been found in many instances, long-continued. The maximum swelling is seen to be accomplished at about 25° C. The general optimum for all of the solutions is, however, probably above this point.

The initial rate of increase at the highest temperature is greatest, but it is soon checked. Etiolated shoots of the same species of *Opuntia* were available and the results of the swelling measurements obtained from them afford some interesting comparisons, although it was not possible to run them as nearly parallel as might be wished. These shoots were 18 to 25 cm. long and 1.5 to 2 cm. in width, some of which were in a chamber at 17° to 19° C. and others in a chamber in which their temperature ranged from 30° to 31° C. Swellings were made at both temperatures, with the results given in table 97.

The most striking feature of the results is the fact that the material etiolated at the higher temperature shows a more extended and greater swelling at the lower temperature. Unfortunately, the fact that the limiting effects of acidity on imbibition increase with rise in temperature was not known at the time these tests were carried out.

If the case of the low-temperature material be taken up, it is seen that its increase is greatest at the high temperature in water, potassium nitrate, acidified potassium nitrate, and acid, while the swelling in alkaline salt and in hydroxid is greatest at the low temperature.

This fact suggests that the general optima of the plants grown at the different temperatures differ in such manner that the one grown at the higher temperature has the lower optimum, and conversely, that the one grown in the cool chamber has its optimum at a higher temperature, which is not necessarily at the point at which the tests were made. The exceptions in the last case in the alkaline solutions may afford a clue to the actual physical conditions upon which such differential

TABLE 97.

	Opuntia etiolated at 17° to 19° C.				Opuntia etiolated at 30° to 31° C.			
	Swelled at 17° to 16° C.		Swelled at 30° to 31° C.		Swelled at 17° to 19° C.		Swelled at 30° to 31° C.	
	<i>p. ct.</i>	<i>hrs.</i>	<i>p. ct.</i>	<i>hrs.</i>	<i>p. ct.</i>	<i>hrs.</i>	<i>p. ct.</i>	<i>hrs.</i>
Distilled water.....	4.2	16	7.5	1.5	13.2	40	3.7	8
Potassium nitrate.....	4.8	30	6.5	6	12.7	48	7.3	8
Potassium nitrate, citric acid, 0.01 N	4.9	3	9.5	1	7.3	4	3.7	1
Citric acid, 0.01 N.....	3.2	3	4	1	4.4	4	3.3	1
Potassium nitrate, potassium hydroxid, 0.01 M.....	13.7	36	9.5	9	.....	.....	.....	.....
Potassium hydroxid, 0.01 N.....	10.6	36	8	1.3	.....	.....	.....	.....

action rests. According to Jenny Hempel, the hydrogen-ion concentration of etiolated lupine shoots was not much different from that of normal green plants, although the actual quantity of acid was much greater. The amount of acid in the plant grown at the higher temperature would, in accordance with general experience, be less than in those grown at the lower temperature.<sup>1</sup> The only suggestions available for an explanation of the behavior in question would rest upon the assumption that the amount of acid was the critical feature, and also that the plants grown at higher temperature had experienced the conversion of the polysaccharids into the pentosans, which have a relatively high coefficient for swelling (see p. 91).

It is to be noted, in any consideration of the action of the colloidal systems, that fresh or living sections of plants are already in the condition of the colloidal sections which have been immersed 4 to 8 hours, and that it is the behavior of the sections after they have taken up 90 per cent of their total capacity for water which comes into the realm of the living plant. Dried sections of plants come down to a water-content not much above that of colloids. It also is to be remembered that in the advanced stages of the desiccation of cell-masses the protoplasmic colloids are subjected to the action of the dissolved electrolytes in a concentrated condition in the final stages of drying. The fixation of the salts and acids which takes place under these circum-

<sup>1</sup> Hempel, J. Buffer processes in the metabolism of succulent plants. *Compt. Rend. d. Trav. d. Lab. d. Carlsberg*, 13: No. 1. 1917.

stances would have such effect that the hydration of the sections would not result in the exact resumption of the former condition of the cell-colloids. The field of action of the colloid within the limits mentioned offers a most promising group of phenomena, the study of which may be expected to contribute in an important manner to knowledge of the mechanics of protoplasm.

Adequate parallel measurements of the effects of temperature on growth of *Opuntia* were not made, but some records are available which show the variation caused by the rise upon material grown at the lower temperature in the above etiolated series. Elongation by growth of the stems in question was at the rate of 5.2 mm. daily at 16° to 18° C. and 11 to 17 mm. daily at 30° to 32° C. The increase amounted practically to a doubling for a rise of 10° C. The swelling in transverse sections of similar material was 4.9 per cent at 17° to 19° C. and 7.5 per cent at 30° to 31° C. in distilled water; and 4.9 per cent at the lower temperature in acidified potassium nitrate and 9.5 per cent at the higher temperature. The increase by swelling transversely was therefore slightly less than double, with a fair inference that it would have been greater in the axis of elongation or growth. It is to be seen, therefore, that in the elongation of the vegetative axes of plants the temperature effect is a complex one, and that the accelerating effect of rising temperature may be primarily an increase in absorption capacity by altered metabolism, including lessened accumulations of acids.

An illustration of the failure of rising temperatures to increase hydration and swelling under some conditions is furnished by the behavior of sections of joints of *Opuntia* taken in a condition of acidosis in the morning. These increased no more at 27° C. than at 20° C. (see p. 119). The experiences with biocolloids must be drawn upon with care when a parallel is sought. The sections of a biocolloid containing the mucilage from *Opuntia* and bean protein were seen to swell 2,400 per cent at 22° C., while the swelling was less than 1,800 per cent at a temperature 5 degrees higher, but the lower figure in this case was probably due to the fact that the plates of colloidal material began to break up and dissolve out at a lower stage of hydration, thus ending the record.

Various tests of material were made for the purpose of ascertaining the conditions prevailing among plants of different types. In mid-April, sections were taken from the terminal elongation internodes of *Phoradendron* growing near the Desert Laboratory, parasitic on *Parkinsonia microphylla*. Such sections were about 3 mm. in length and half that thickness. Swelling was 3 and 5 per cent in distilled water at 20° and 30° C., respectively, but no appreciable difference could be detected between the increases in hundredth-normal citric acid at the two temperatures.

The petioles of some young plants of a *Solanum* hybrid in the glass-house at Tucson were available on April 21, 1918. Two series of sections were placed in distilled water and acid at 18° and 38° C., with results shown in table 98.

TABLE 98.

	18° C.	38° C.
	<i>p. ct.</i>	<i>p. ct.</i>
Distilled water.....	4.2	11.8
Citric acid, 0.01 N..	4.2	2.6

TABLE 99.

	18° C.		38° C.	
	<i>a.</i>	<i>b.</i>	<i>a.</i>	<i>b.</i>
	<i>p. ct.</i>	<i>p. ct.</i>	<i>p. ct.</i>	<i>p. ct.</i>
Distilled water.....	14	8	9.6	11.7
Citric acid, 0.01 N..	11	9.7	6.6	4.4

The swelling in distilled water was nearly three times as great at the higher temperature, while in the acid solution a retardation took place which limited the total at the higher temperature to something over a half that possible at the lower point. The total swelling in acid at the lower temperature occupied an hour and at the higher temperature it was a matter of 10 or 15 minutes. A similar speeding-up of imbibition in water was observed. The total capacity at the lower temperature was not reached for 8 or 10 hours, while at the higher it was something under 2 hours.

Plants of *Phaseolus* which formed the experimental material for measuring the growth of pods and seeds bore some pods in which the beans were nearly mature. Pods of the same stage of development as one which was under the auxograph for recording daily changes (see p. 156) were opened and the unripe beans removed. The ends were cut away and the outer coat removed. The remainder of each cotyledon made one section, of which three were taken from separate pods for swelling. The average thickness was 3.2 to 3.4 mm. and the swellings of duplicate series were as given in table 99.

The higher temperature to which series *a* was subjected appears to be above the point at which maximum absorption or imbibition takes place in distilled water, as the swelling was 30 per cent less than at the lower temperature. The retarding effect is much more marked in the acid solution, however, as the reduction of the total capacity below that shown at 18° C. amounted to 40 per cent.

The material in series *b*, taken at a later date and with seeds which seemed to be more nearly mature, showed an increase in swelling in distilled water of about 45 per cent over the total at the lower temperature, while the swelling in acid was less than half that at 18° C. The average of the two series is such that the swelling in distilled water is nearly the same at both temperatures, while in acid the average at 18° C. is 10.4 per cent, which is nearly double that at 38° C., at which point the hydration capacity seems to be invariably lower than at the lower temperature. These averages represent a total of 6 cotyledons each.

A final test of variations in temperature upon material in an acidified condition was made with dried sections of *Opuntia*. These sections were made by slicing away the chlorophyllous layer from one side of the flat joint and drying the remainder in the desiccator and in sheets of blotting-paper in such manner that buckling and crumpling were prevented. After all of these precautions were taken, however, the measurement of the sections was subject to some error, due to the fact that the fibrovascular strands remaining would increase the thickness under the calipers without reacting in due proportion to the action of the swelling agent. A wide range of figures was obtained, but it was apparent that a rise in temperature did not have an effect on material in acid equivalent to that in distilled water, as will be apparent from the measurements obtained from sections which were 0.43 to 0.46 mm. in thickness (table 100).

TABLE 100.

	Swelling at 18° C.			Aver- ages.	Swelling at 28° C.	Swelling at 38° C.		Aver- ages.
	<i>p. ct.</i>	<i>p. ct.</i>	<i>p. ct.</i>	<i>p. ct.</i>	<i>p. ct.</i>	<i>p. ct.</i>	<i>p. ct.</i>	<i>p. ct.</i>
Distilled water.....	315	385	486	395	453	500	413	457
Citric acid, 0.01 N.....	360	430	460	417	460	477	400	439

The increase in swelling in distilled water is seen to be about twice that in the acid in the rise from 18° C. to 38° C. The influence which the condition in question may exert on the rate of growth is obvious. Thus the course of enlargement of an organ or of a cell-mass, in so far as this consists in hydration, may vary widely in the first instance, because of the residual acids in the colloids, and the balance or accumulation of this will in turn depend upon the effect of the enzymic or respiratory processes in metabolism. It is obvious that a rise of 10 degrees from the customary morning temperature of 15° C., which has accompanied so many of these experiments, might result in an acceleration of growth determined by the reduced acidosis of the plant. A rise from the same temperature later in the day or under other conditions of illumination would necessarily have a different result. An extension of the attempts to bring rates of growth into a figure or formula, therefore, would be a forced application of knowledge of one process to a complicated procedure which results in no positive advance. Variation of temperature results in modification of the rate of enzymic processes and of the forms of metabolism included under and associated with respiration, in modification of the rate of absorption of water by the organism from its medium or substratum, and modification of the water-holding capacity of the cell-colloids after a mode determined by their carbohydrate-protein ratio and by their state of acidosis. The actual increase in volume, will also be influenced to some extent by the continual water-loss from the surface.

The conception of a temperature coefficient of growth must be taken as an integration of the action of a constellation of forces acting upon colloidal material of varying constitution.<sup>1</sup> The agencies in question do not run parallel in their effects and interlock in the most intricate manner.<sup>2</sup> It is not surprising, therefore, to find that the coefficient of temperature as applied to growth, which is usually calculated in terms of relative effect for each variation of 10° C., has but little usefulness, except between 10° and 30° C.<sup>2</sup> The value of  $Q^{10}$  as it is usually written varies between 1.12 and 5 or 6, and the variation in any given organism is usually very great above 30° or 35° C. Thus, in my own experiments with *Opuntia*, the actual range of growth was found to extend from as low as 7° C. under some circumstances to 51.5° C. under others, but no single individual was seen to grow throughout this range. The combination of conditions which would enable it to do so are not likely to occur in a state of nature and would be difficult to bring about experimentally.

In addition to the complexities of interplay of molecular forces to be reckoned with—and they appear most formidable to the chemist familiar with their nature—the application of ratios or formulæ to variations in growth produced by temperature in the higher plants encounters still other difficulties. Chief among these is the fact that the growing region of a plant may vary in actual and relative amounts of embryonic cell-masses and of fixed non-expanding tissues. External measurements of elongation, even when applied to root-tips, may have, in consequence, but doubtful value.

A brief description has been given on page 96 of the unsatisfied water capacity of the corms of *Brodiaea*, from the apices of which two or three leaves 20 to 30 cm. long arise and elongate by the action of a mass of embryonic cells, which maintain a basal position during the entire development of the leaf. The corms habitually lie 5 to 10 cm. below the surface of the soil and the growing region operates under the influence of the soil, not the air, temperature. It was therefore arranged to grow some of these plants in pots, taking the temperatures by thermometers thrust into the soil, in the vicinity of the bulbs. Such cultures in small chambers with thermostatic control yielded some data of interest. An attempt was made to ascertain the relative rates of increase or amount of water which might be absorbed by the corms and by the growing regions of the leaves at different temperatures. A trio of corms, each of which consisted of the older basal corm and the recently formed younger one, having an average height of 12 mm., were at first swelled to saturation at 19° C. and after two days, when quiescence had been reached, the preparation was placed in a warmer

<sup>1</sup> Osterhout, W. J. V. Some aspects of the temperature coefficients of life-processes. *Jour. Biol. Chem.*, 32: No. 1, p. 23. 1917.

<sup>2</sup> See Barry, F. The influence of temperature upon chemical reactions in general. *Amer. Jour. Bot.*, 1: 203-225. 1914.

chamber, where the water in which they were immersed was raised to 28° C. and kept at that point for 40 hours. Increased imbibition ensued, which resulted in an elongation of 1 mm. or 8 per cent of their total height. Measurements of the growth of leaves arising from the apices of such corms showed that they maintained a rate of about 0.25 mm. per hour at air-temperatures of 19° C., which was increased to 0.49 mm. per hour at 27° to 28° C.; the temperature coefficient of such elongation would thus be nearly 2.5.

A second pair of preparations with young leaves about 10 to 12 cm. long was placed in a small, well-lighted thermostat, and the apices of the second or younger leaf were attached to the auxographs. The action of these plants was followed for a period of about 20 days, during which time the leaves reached a length of 25 to 30 cm. The growing region remains basal to the leaf and the rate of growth during the course of development is much flatter than in stems, presenting some of the features of root-tips.

Three objects were in view in the measurements of the rates of elongation: (1) estimation of the rate in alterations from a low to a high temperature and *vice versa*; (2) accelerations due to changes from one temperature to another; (3) the effects of small and of wide variations in temperature.

The principal data concerning the experiment are given in table 101.

TABLE 101.

No. 1			No. 2		
	Rates per hour for—	At tempera- tures of—		Rates per hour for—	At tempera- tures of—
mm.	Hrs.	° C.	mm.	Hrs.	° C.
0.24	24	31-33	1.7	12	25-27
0.1	24	9.5-11	0.11	24	9.5-11
1.1	18	20.5-21.5	0.8	15	19.5-21
1.4	7	20-21	1.1	7	19-20
0.3	11	9-10	0.4	11	9-10
1.2	8	19.5-20	0.9	8	19-20
0.6	12	8-9	0.27	12	8-9
1.4	4.5	27-28.5	1.22	4.5	26-27.5
0.3	10	7	0.3	10	7
1.25	6	20-21	0.8	6	19-20
2.25	8	28	0.9	5	30-31
0.7	5	33	0.7	9	20-21
0.7	9	23	0.3	5	17
0.15	5	17	0.8	6	27-28
0.27	15	30-31	0.2	15	17
0.2	15	17	0.5	28	17
0.5	28	17	1.1	15	26-28
1.7	7	26-28	0.7	12	17-18
0.6	16	16-17			

The maximum rate displayed was at a temperature slightly under 30° C., varying, of course, with the preceding experience. Rising temperatures are seen to accelerate growth with a coefficient slightly



above 2, except in cases in which the rise carried the temperature to 30° C. or above and also when the change was as much as 20° C. In the earlier stage of development the rate rose from 0.1 mm. per hour at 11° C. to 0.8 mm. per hour at 21° C., and in another leaf from 0.1 mm. to 1.1 mm. per hour in passing from 9° to 20° C. A change from 9° to 27° C. resulted in a decreased rate in one case, while in others raising the temperature from 27° or 28° to 33° C. had no effect.

Falling temperatures were accompanied by reductions, with a usually lower coefficient, it being noticeable that, as exceptions, the rate in one case decreased from 0.7 mm. per hour at 23° C. to 0.15 mm. per hour at 17° C., while in another case the rate decreased from 0.8 mm. per hour at 27° C. to 0.2 mm. at 17° C. This unusual reduction is ascribed to the fact that the door of the thermostat was opened to facilitate the cooling, which resulted in the exposure of the leaves to low relative humidity during the greater part of this period.

Closing the chamber and continuing the temperature of 16° to 17° C. for 28 hours longer gave a record in which the rate gradually rose from the low figure mentioned to 0.5 and 0.6 mm. per hour, which was nearest the expectancy in comparison with the rate of 0.7 mm. per hour at 23° C. which had been displayed in the previous period.

In the following period a rise of temperature from 17° to 26° or 28° C. was accompanied by accelerations of 0.5 to 1.7 mm. and from 0.5 to 1.1 mm. per hour. The reversal of the temperatures brought the rates down to 0.6 mm. from 1.7 mm. in a change from 28° to 16° or 17° C. and from 1.1 mm. to 0.7 mm. in a change from 26°-28° to 17°-18° C. No other variations were observed in the three weeks in which these organs were under observation which could be ascribed simply to the change of temperature. Usually the change in the thermostatic temperature would be followed within an hour or two by that of the soil around the bulbs and the result would be a gradual adjustment of the rate, increasing or decreasing, with no breaks or erratic features, in the tracings which gave a continuous records of the lengths.

In conclusion, it is to be pointed out that the foregoing observations show that the hydration capacity of cell-masses may bear some relation to the temperature at which they are formed and under which they have functioned for some time, and also that the unsatisfied water capacity of a tissue will be affected by the relation between absorption and water-loss by transpiration. Some gross measurements, which have been made with an accuracy quite adequate for the determination of the point in question, show that plants in the tropics show a rate of growth which may be directly correlated with relative humidity and the transpiration to be inferred.

Retardation of growth of an organ of a higher plant may be the result of such direct water-loss, or, on the other hand, it may be directly connected with the lessening of the water capacity of colloidal masses

under acid conditions, as has been demonstrated both in sections of pentosan-protein biocolloids and in living and dried sections of plants.

The application of a temperature coefficient derived from a simple equation to the rates of growth of organs of green plants has a certain practical value when temperatures between the minimum and the maximum rate are under consideration. As changes in temperature affect a number of constituent processes in growth, including absorption and diffusion, transpiration, adsorption, action of acidity or hydrogen-ion concentration, formation of the amino-acids, enzymic action and oxidations, and all transformations of the carbohydrates, the empirical character of such indices must be kept well in mind. The character of temperature coefficients is sufficiently indicated by the fact that they are not found to apply through the range of practicable or habitual conditions of the organism and that the values change within the range of 8° to 30° C. when falling and rising temperatures are contrasted.

## X. IMBIBITION AND GROWTH OF OPUNTIA.

Living cells and colloidal masses are never in a state of perfect equilibrium with the environment, and the possible adjustments in growing cells in which the colloidal substances are increasing, changing in constitution, and varying in condition, may be great both as to velocity and amplitude. Artificially compounded colloids, such as the agar-protein mixtures which have been so freely used in this work, show a similar delicate series of adjustment and correlations as they pass from the dry state to one of almost completely satisfied hydration; but when they reach this stage they are in the general condition of mature cells or tissues and then show only the minute adjustments which follow the modifications of the environment very closely. Living cell-masses are to be considered as masses of colloid the intimate substance of which is being constantly altered by metabolism and by the incorporation of new material. The actual capacity of a gel for water and its consequent state of swelling may be practically satisfied at any stationary temperature. Such equable temperatures do not occur in natural environments and may be observed only in control chambers. The pen of the instrument employed in methods of accurate measurement of a hydrated mass of colloid indicates constant variations in volume, due to the solvation or dispersion of some of the mass in the water in which it may be immersed.

The swelling of a cell-mass is to be considered as determined by the hydration capacity of its colloids at the beginning of immersion plus whatever additional capacity or variation may be developed by the rearrangement of its material, reformation of its compounds, and migrations of its molecular aggregates. Of the increased volume characterized as growth, 98 per cent results from hydration. The growing cell-mass, however, in addition to the initial hydration capacity of its mass, is continually adding material which has hydration capacity, and metabolic activities result in the accumulation of acids and other substances which affect the coefficient of swelling. The major procedure in growth would theoretically be imitated if minute particles of powdered colloid could be continuously introduced into a swelling mass.

Measurements of hydration in plants were made with disks about 12 mm. across, cut from the flattened joints of an opuntia, which ranged from 5 to 20 mm. in thickness (fig. 23). Such sections consisted of the indurated epidermal layers, between which was a cylindrical mass of parenchymatous cells, the outer ones being chlorophyllose. An anastomosed network of thin, fibrovascular strands was included in the parenchymatous mass, and this mechanical tissue checked expansion, so that care was necessary not to include the larger, firmer strands in the section. Three of such disks about 12 mm.

across the epidermal surface and from 6 to 11 mm. in thickness were arranged in a triangle in the bottom of a Stender dish and a triangle of thin sheet-glass arranged to rest its apices on the three disks (see fig. 1) The vertical swinging arm of an auxograph was now adjusted to a shallow socket in the center of the glass triangle, while the pen was set at zero on the recording sheet. Water or a solution being poured into the dish, the bulb of a thermometer was adjusted in it and the course of the swelling was traced, the record showing the average result of the action of the trio of specimens.<sup>1</sup>

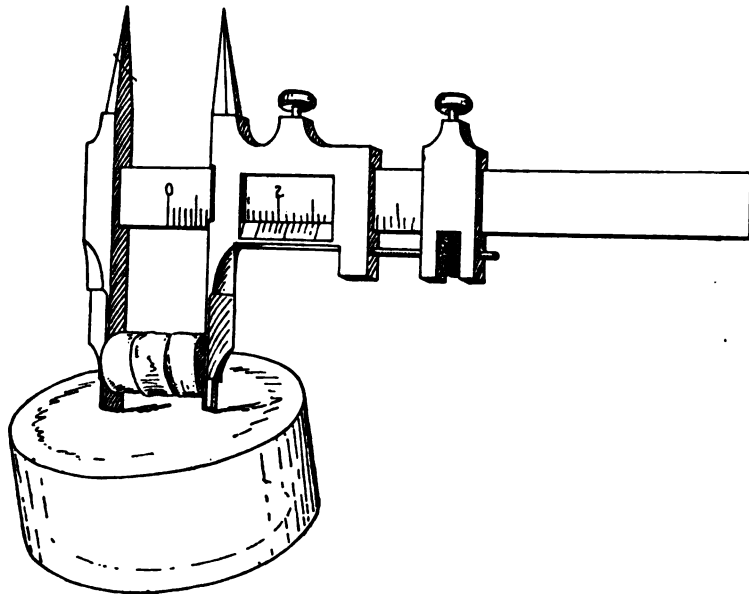

FIG. 23.—Calipers used in obtaining thickness of trio of sections. Swelling is calculated on average.

Extensive records of the growth of the flattened joints of certain platyopuntias having been made at the Desert Laboratory, and as a series of analyses of the carbohydrate constituents of these plants was being carried out, parallel measurements were planned which might show possible connection between the composition of these members and their imbibition or swelling reactions. The first series began with the young joints which are formed in April and May, reaching maturity in about 40 or 50 days and extending through the seasons, including the dry foresummer, the summer rainy season, then the dry after-summer, merging into the winter with its final rainy season. The imbibition capacity of sections taken from the joints ran a course shown in table 102.

<sup>1</sup> MacDougal, D. T. Imbibitional swelling of plants and colloidal mixtures. *Science*, 44: 502-505. 1916. Also MacDougal. Mechanism and conditions of growth. *Mem. N. Y. Bot. Garden*, 6: 5-26. 1916.

TABLE 102.—Swelling of joints formed in 1916.

	Water.	HCl, 0.01M.	NaOH, 0.01M.
	<i>p. ct.</i>	<i>p. ct.</i>	<i>p. ct.</i>
May 18, 1916.....	24.3	30.0	40.0
June 2, 1916.....	23.6	16.4	22.9
Nov. 2, 1916.....	20.5	21.0	22.2
Nov. 23, 1916.....	48.0	45.4	35.3
Jan. 24-25, 1917 (12 sections)...	25.7	27.9	25.0
Feb. 20-21, 1917 (6 sections)....	10.7	11.7	10.8
Mar. 23-24, 1917 (6 sections)....	9.4	12.0	10.9
Apr. 24, 1917.....	21.8	20.4	13.9

No record was made of the temperatures of the swelling sections, but these in general were determined by the seasonal conditions. Thus, sections were swelled in November at 16° to 18° C. and at 25° to 28° C. in April and May.

The measurements given in table 102 were made primarily for the purpose of following the changes in the flattened stems of *Opuntia* as they go toward maturity. The joints, having reached the mature condition in November, the changes for the next 4 or 5 months are not directly connected with growth, although the action of living cells is concerned. The period of late summer is one of progressive desiccation, in which the water-loss is much greater than the supply obtained from the soil, and this drying out continues until some time in January and February, when the winter rains saturate the soil. It would be expected that if sections of the partially desiccated plants were taken during the dry period, the swellings which they would show when placed in solutions would be a direct function of the net water-loss which they had sustained, rather than of changes in composition. It was therefore necessary to devise a method by which the material could be reduced to a standard in which the seasonal water-condition would be eliminated. This was accomplished by the use of dried slices from the median portion of the joints in such manner as to exclude nodes and spines.

The joints were laid flat on a table and against a strip of wood 5 or 6 mm. in thickness, which served as a guide for sliding a knife to cut away one epidermal region. This being done, the piece was turned over and a horizontal movement of the knife along the lowered guide would cut away the other epidermal region, leaving a slice 3 to 5 mm. in thickness, which was dried in the air at temperatures of 15° to 18° C., using filter-paper or blotting-paper to keep the sections plane during a part of the process. Sections cut from the dried pieces were calibrated by scales of the type used commercially for measuring the thickness of paper (fig. 8), and then swelled under the auxograph in the usual manner. The calculation of the percentage of swelling on the final thickness of the dried material eliminated the factors attendant upon

the condition of the fresh material. It is important that the thickness of the slices before drying be approximately equivalent.

The measurements obtained from living sections inclusive of the entire thickness of joints and from dried slices, given in table 103, illustrate the seasonal variations in mature stems.

TABLE 103.—*Swelling of mature joints at different seasons.*

Date.	Solutions.			
	Water.	Citric acid, 0.01 N.	Sodium hydroxid, 0.01 M.	Potassium chloride, hydrochloric acid, 0.01 M.
Oct. 1917 (living sections) (18–25° C.).....	<i>p. ct.</i> 98	<i>p. ct.</i> 116	<i>p. ct.</i> 100	<i>p. ct.</i> .....
Dec. 1917 (dried slices) (16–18° C.).....	277	300	177	.....
Jan. 3, 1918 (living sections) (16–18° C.).....	214	238	.....	.....
(Dried slices) (12–14° C.).....	194	317	282	.....
Jan. 24, 1918 (living sections).....	55	80	85	.....
(Dried slices) (16–18° C.).....	143	143	143	.....
March 4, 1918 (living sections).....	20	14	14	14.3
(Dried slices) (18–20° C.).....	238	210	210	210
March 30, 1918 (living sections).....	4.8	5.5	5.7	3.5
(Dried slices) (20–22° C.).....	550	463	600	388
Apr. 25, 1918 (living sections).....	37	40	36.5	37
(Dried slices) (23° C.).....	304	322	310	274
May 28, 1918 (living sections).....	54	51.6	50.3	42.7
(Dried slices) (20–25° C.).....	195	166	208	230

The continued dry condition is seen to result in desiccation, which, of course, is followed by increased hydration when such living sections are swelled, the maximum effect being reached in January, before the beginning of the winter rains.

The tests of the dried sections which show the swelling after the colloids have been subjected to the action of concentrating salts have a value derived from the fact that all are reduced to an equivalent water-content, accompanied by irreversible coagulations of the more complex proteins. Although we here introduce a new set of conditions, the effects of which are not easily to be evaluated, yet it is none the less significant that the entire series of preparations reach their maximum water capacity at the end of March. Since some changes may have been brought about in the proteins, it is important to follow the course of the carbohydrates.

The variation in the sugar-content is best illustrated by the data given in table 104, as determined by Dr. Spoehr.<sup>1</sup>

It is clear that the colloidal material of the cell-mass of this plant does not come to a condition of highest imbibition capacity at the end of the period of desiccation in the season of low temperature, but the maximum is found after the beginning of a season of rising temperatures and of accumulating sugars, coupled with an inadequate water-supply.

<sup>1</sup> Spoehr, H. A. The pentose sugars in plant metabolism. *The Plant World*, 121: 366–379. 1917.

The extended measurements of the swelling of biocolloids containing sugars, dextrose and sucrose, and of such mixtures in solutions of sugars, show that these have but little influence upon imbibition capacity. These results suggest that it is to the variations in the pentoses as represented by the mucilages of the opuntias that we must look for a part of the varying imbibition capacity of these and perhaps other plants as well.

TABLE 104.—Seasonal variations in sugar-content of *Opuntia* sp.

	Date.										
	July 5.	July 31.	Sept. 20.	Oct. 27.	Nov. 15.	Dec. 20.	Jan. 11.	Feb. 16.	Mar. 17.	April 25.	May 22.
Dry weight.....	36.38	16.45	19.66	20.30	23.05	30.10	22.20	22.33	19.50	24.30	25.25
Total sugars, p. ct.....	20.03	13.24	18.44	20.90	18.75	28.95	19.10	21.32	28.05	32.40	30.15
Total hexose sugars, p. ct....	10.45	8.60	8.83	9.32	5.50	7.90	14.95	14.90	22.16	22.70	17.08
Total pentose sugars, p. ct...	9.26	4.39	9.08	10.95	12.50	10.45	4.73	6.07	5.55	9.15	12.34
Pentosans, p. ct.....	9.04	.....	8.86	10.47	11.35	10.10	4.40	5.51	4.75	8.68	12.17
Pentoses, p. ct.....	0.20	.....	0.24	0.48	0.82	0.35	0.43	0.55	0.82	0.48	0.16
Ratio of total pentose sugars to total sugars.....	0.462	0.332	0.492	0.524	0.667	0.551	0.248	0.283	0.198	0.283	0.409
Ratio of total hexose sugars to total sugars.....	0.522	0.650	0.479	0.446	0.293	0.417	0.733	0.698	0.791	0.702	0.567

The vegetative conditions at the Coastal Laboratory are widely different from those at the Desert Laboratory, at which the above results were obtained. Sections of fresh material at the end of August at the first place showed swellings of 7 to 10 per cent at temperatures of 15° to 16° C. This was characteristic of the end of the summer cool and foggy season. Higher temperatures and greater average daily illumination resulted in increased desiccation during August and September, with the result that living sections showed an unsatisfied imbibition capacity of 18 per cent at 15° to 16° C. The method of preparing dried median slices was developed at this time, and these showed swellings of 500 per cent at 15° C. and 570 per cent at 20° C. The total proportion of pentose sugars at this time was 19.10 per cent as compared with 4.39 per cent at Tucson, calculated on dry weight. Dried sections at the Coastal Laboratory taken at the end of January, after 2 months of the cool season but with a fair supply of moisture, were found to swell 300 per cent at 14° to 16° C. A test was also made of sections comprising only the epidermal and chlorophyllose layers of the same material, and these were found to show an increase of 262 per cent at the same temperature.

Decrease in swelling capacity is seen to occur in the cool season at Tucson and at Carmel. The composition of the joints in September, representing approximately the condition of the material at both places in October, as determined by Dr. H. A. Spoehr, is shown by table 105.<sup>1</sup>

<sup>1</sup> MacDougal and Spoehr. Growth and imbibition. Proc. Am. Phil. Soc., 56: 289. 1917.

The material to which the high hydration capacity of *Opuntia* is due is the mucilage which exudes from the damaged cells of cut surfaces of the parenchymatous tissues. This is included among the pentosans together with agar and various gums, including tragacanth, acacia, cherry gum, and prosopis gum, many of which have a high hydration capacity and infinite dispersion in water.

The manner of the formation of this material is a matter of no little importance in connection with varying growth and hydration capacity. Briefly stated, the depletion of the water-content of a cell accelerates the conversion of polysaccharids with low hydration capacity into pentosans (mucilages and gums) which have an extremely high water capacity,

and it is this change which is followed by the large swelling of tissues in certain stages or in dry seasons. The transformation in question is not reversible. While some decrease in these pentosans may occur, it is not known by what steps it takes place.<sup>1</sup>

The composition of etiolated plants presents proportions of the principal constituents different from those of the green plant, and if one of the main conclusions of the present work is valid, they might be expected to exhibit some water-relations different from those of green plants.

Some shoots of *Opuntia* which had developed in a dark room at Carmel in equable temperatures below 20° C. were available in July 1917, and these displayed some singular temperature effects. The stems were from 20 to 30 cm. long and compressed ovate in cross-section. Short sections were cut out and immersed in dishes in the usual manner. Most of the development had been at 16° to 18° C., and some of the shoots were placed in a second chamber at 30° to 31.1° C. for 2 days before being swelled. The illumination of a small incandescent bulb used in obtaining these measurements had given the stems a slight greenish tinge, but the energy derived from this source was not sufficient to have caused any serious change in the composition of the shoot. Sections were about 5.5 mm. in diameter, and sets of three were selected for testing under the auxograph, so that the older basal parts of the stem and the newest apical portions were represented in the separate measurements. One

TABLE 105.

	Carmel.	Tucson.
	<i>p. ct.</i>	<i>p. ct.</i>
Water.....	91.15	80.34
Total sugars.....	2.61	4.30
Total polysaccharides.....	1.94	3.50
Hexose polysaccharides...	.09	1.65
Disaccharides.....	.07	.04
Hexoses.....	.52	.06
Pentoses.....	.14	.05
Pentosans.....	1.70	1.74

<sup>1</sup> See MacDougal and Spoehr. The origination of xerophytism. *The Plant World*, 21: 245. 1918. Also MacDougal, Richards, and Spoehr. The basis of succulence in plants. *Bot. Gas.*, 67: 405. 1919.



series was swelled at the temperature of 30° to 31° C., at which the shoot had stood for several days. The second series was swelled at 17° to 19° C., in which equivalent shoots stood, which were to be used as a comparison.<sup>1</sup>

The most remarkable feature of these measurements is that in which the material grown at 30° to 31° C. for two days showed a greater increase when swelled at a lower temperature (see p. 119). The entire set of reactions is indicative of a colloidal complex of different constitution from that of green plants.

Analyses necessary to establish the nature of such divergent constitution of etiolated opuntias could not be made, but data obtained from other species grown in darkness are available. The results of Palladin show that stems of such plants have less nitrogen than normal green plants, and all workers who have dealt with this subject agree that the ash-content of etiolated organs is relatively greater than in green stems.<sup>2</sup>

There is not general agreement as to the distribution of nitrogen in etiolated plants, but there seems to be unanimity in the conclusion that the total nitrogen-content is less than in normal plants. According to Karsten, all parts of the plant have less sugar and "gums" when grown in darkness.<sup>3</sup> As the gums include the pentosans, which with the nitrogenous compounds make up the hydration machine, it is to be seen that the etiolated plant presents the features of lessened protein, decreased pentosans, and increased salts, all of which would tend to a lessened imbibition capacity in both fresh and dried material. How much the lessened nitrogen-content would contribute to this general decrease might only be known by a determination of the character of the compounds in the two instances.

All of the facts concerning imbibition by living plants and by biocolloids tend to show that the proposal of Palladin to ascribe the various departures of growth in plants in darkness to transpiration effects is not tenable. There is much foundation for the belief that form may be largely affected by the water-relation, but with respect chiefly to imbibition capacity, as a resultant of the protein-pentosan-salt complex with varying acidity. It would seem, therefore, that for Palladin's contention that the ash constituents of the etiolated plant exercise a determining effect on the growth and development in darkness by influencing transpiration, we may safely substitute an assertion that the important effect of the salts is that which they have on the imbi-

---

<sup>1</sup> MacDougal. The influence of etiolation upon chemical composition, in "The influence of light and darkness upon growth and development." Mem. N. Y. Bot. Garden, 2: 300-305. 1891.

<sup>2</sup> Palladin, W. Eiweisgehalt der grünen und der etiolirter Blätter. Ber. d. deut. bot. Ges., 9: 191. 1903.

<sup>3</sup> Karsten, H. Die Einwirkung des Lichtes auf das Wachstums der Pflanzen. Jena. 1870.

tion or absorption action of the plasmatic colloids, which in the case of *Opuntia* are probably low in proteins.<sup>1</sup>

The growth of etiolated shoots of *Opuntia* is of an indefinite character, as the length which such members may reach depends to a large extent upon the amount of available material and other features. Shoots which were already a few weeks old, and which had developed in a dark chamber kept at 16° to 18° C. were found to be growing at the rate of 5.2 mm. daily. These were removed to a second chamber, in which the temperature was kept steadily at 16° C. for 3 days, during which time the rate varied from 3.1 mm. to 3.4 mm. daily. The temperature was brought up to 21° to 23° C. in 3 hours, and the rate was 5 mm. for the first day. During the second and third days at this temperature the rate rose to 7 mm. per day. The rate was 7.6 mm. daily during the next 2 days and about 8 mm. daily for a final period of 16 hours. The temperature now being raised to 30° C. in 2 hours, and after that varying from 30° to 32.5° C., the rate was 11 mm. daily during the first 16 hours, then at the rate of 16.8 mm. during the succeeding 12 hours, during which time the elongation progressed in a remarkably uniform manner.

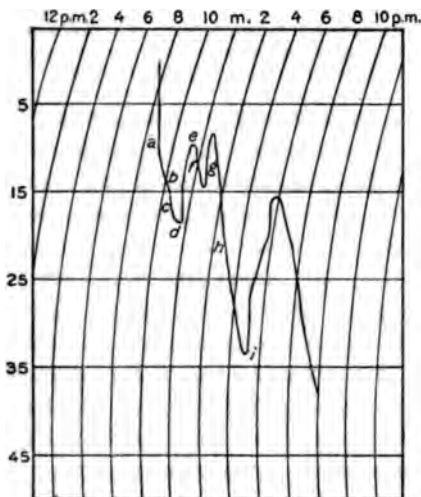

FIG. 24.—Auxographic record of variations of length of etiolated shoot of *Opuntia*  $\times 26$ , at temperatures as below, sheet ruled to 10 mm. intervals: (a) downward movement of pen 7<sup>h</sup>30<sup>m</sup> a. m. to 9<sup>h</sup>40<sup>m</sup> a. m. denoting growth at temperatures of the stem of 45° to 49° C.; (b) growth checked for 20 minutes at 49° C.; (c) growth resumed at temperature of 49° C.; (d) shortening at 48.5° to 52° C.; (e) stationary at 50.5° C.; (f) growing at temperatures of 48° to 49° C.; (g) shortening at 49° C.; (h) growing at 38° to 41° C.; (i) shortening at 49° C.

The rate itself was one which might have been identified with that of a green plant, in which, however, the length of the cell-mass might not be equivalent. The chief point of interest in the present connection is that which comes from a comparison of the imbibition capacity and growth. Sections grown at 17° to 19° C. showed an imbibition capacity at 30° to 31° C., nearly double that displayed at the lower temperature, and it was also to be seen that shoots growing at the rate

<sup>1</sup> Palladin, W. Transpiration als Ursache der Formänderung etiolierter Pflanzen. Ber. d. deut. bot. Ges., 8: 364. 1890.

of 5.2 mm. daily at 16° to 18° C. showed a rate of 11 to 17 mm. daily at 30° to 32° C. The rate of growth would be one which would be accepted as being in general conformity with the van't Hoff formula of chemical reaction, while as a matter of fact it is not widely different from the capacity for imbibition under the influence of equivalent temperatures. Experimental tests have already been described in which the upper limits of growth and the behavior of etiolated and green stems of *Opuntia* between 46° and 51.5° C. are not widely different. (Fig. 24.)<sup>1</sup>

The rapid and wide variations at these high critical temperatures are to be contrasted with the steady rate of a growing green joint maintained at 30° C. for 38 hours. The illumination in the daylight period apparently did not affect the rate of 0.07 mm. per hour.

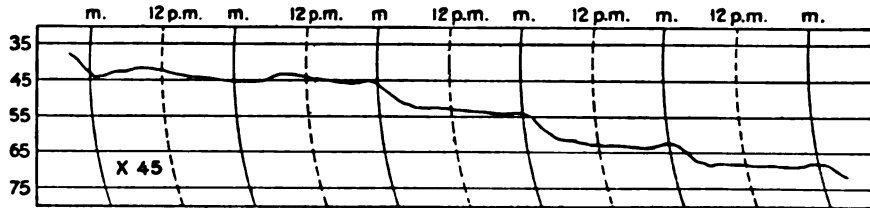

FIG. 25.—Tracing of auxographic record of variations in thickness of joint of *Opuntia* approaching maturity. Upward movement of pen denotes increase in thickness, X45. Measurements made from place between areoles near base of joint. Scale ruled to 5 mm. and 12-hour intervals. It is to be noted that the hour is set forward on the summer schedule.

In addition to the great number of records of the variation of joints of *Opuntia* as to length, a few days' measurements of the thickness of a maturing joint were made in April 1918 in order to ascertain whether or not increases and shrinkages took place in all dimensions at the same time. The auxographic tracing in figure 25 gives the daily variation in thickness near the base of a maturing joint, which are seen to be correspondent to those in length. It is to be noted that the instrument was necessarily adjusted so that increase was denoted by the upward movement of the pen, in a manner opposite to that in nearly all the other records. Later the bearing-lever of the instrument was adjusted to a place near the apex of the joint and the shrinkage, which was now pronounced, was seen to set in about 9 or 10 a. m. and continue until sunset, at which time thickening began and lasted for 3 or 4 hours, after which but little change took place until the rising temperature of the following day was encountered.

The singular retardations and variations in growth which are highly characteristic of *Opuntia*, together with its unusual features of transpiration and its readily measurable imbibition, offer unusual opportunities for the examination of certain agencies affecting growth, especially as the action of some of these factors is so plainly discernible in the variations in volume of mature organs.

<sup>1</sup> MacDougal and Spoehr. Growth and imbibition. Proc. Amer. Phil. Soc., 56: p. 308. 1917.

The size or swelling of any colloidal mass, such as a growing organ, or particularly a joint of *Opuntia*, will depend upon the integrated effects of several agencies, including transpiration, absorption, the hydration coefficient (as determined by the acid, salt, and protein content of the protoplasm), and the temperature.

Several series of measurements of the separate processes involved have been made at the Desert Laboratory. The earliest results of importance with reference to transpiration as affecting growth were obtained by Mrs. E. B. Shreve, who found that the actual amount of water which an excised section of one of the cylindropuntias, *Opuntia versicolor* (fig. 26), might contain begins to decrease some time after midday and continues to do so until about daybreak of the following morning, then increases during the forenoon.<sup>1</sup> If the plant

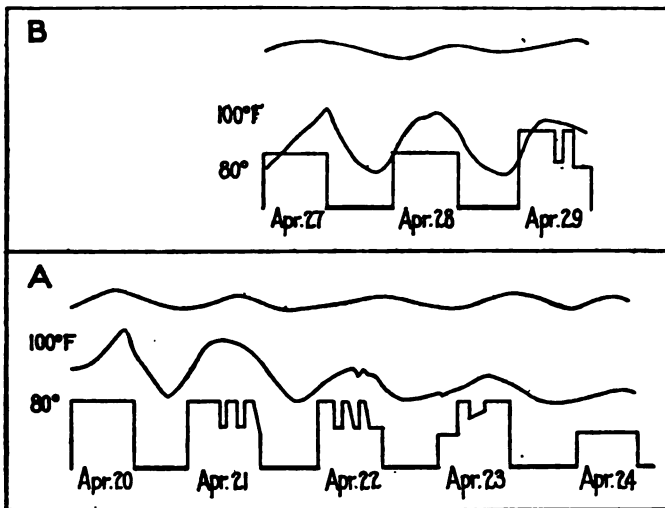

FIG. 26.  
A, tracing of an auxographic record of the variations in length of a stem of *Opuntia versicolor*. Below is a line showing the daily variations in temperature. The graph is composed of sections of straight lines representing conditions of illumination. Interruptions of the sunlight by cloudiness are shown on April 21, 22, 23, and 29. B, auxographic record of variations in thickness of stem of *Opuntia versicolor*, with temperature and illumination indicated. (After Mrs. E. B. Shreve.)

was under conditions of satisfied imbibition capacity, the plotted line showing such capacity would also be that of growth. Such a condition does not exist, however. Also, if the simple capacity for imbibition determined volume, and this capacity were always satisfied, the plotted line of water capacity might be identical with that of the daily variation in volume of the mature organ. Neither does this condition exist (fig. 27).

The record of variations in volume of a joint from the time of its beginning to maturity and through the following season, and selected portions of this graph, are reproduced in figures 28 and 29.

The aspect of the daily variations in volume shows seasonal alterations and depends to some extent upon the age of the mature joint, but it is evident that the joint begins to increase in volume in the

<sup>1</sup> See Shreve, E. B. An analysis of the causes of variations in the transpiring power of cacti. *Physiol. Researches*, 2: No. 13. August 1916.

morning or at some time in the forenoon and continues to do so until some time late in the afternoon, at which point a shrinkage ensues which continues until the next morning. The rate of water-loss was not parallel with the changing volume, as transpiration was most rapid between midnight and morning, and was in excess of the amount which might

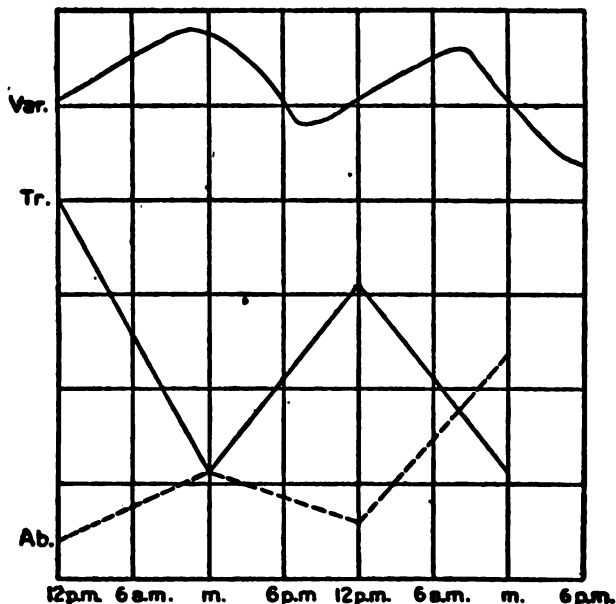

FIG. 27.—Absorption, transpiration, and variation in length of growing shoot of *Opuntia*. Absorption by roots denoted by dotted line is least about midnight and is greatest about midday, exceeding transpiration during the greater part of the daylight period. Transpiration is greatest about midnight and least about midday, according to data by Mrs. E. B. Shreve. The wavy line is an auxographic tracing of actual changes in length of a joint of *Opuntia* in a mature condition,  $\times 50$ .

be absorbed by the roots during this period. It is obvious without further discussion that the variation in volume of a member like that of a joint of *Opuntia* must be the resultant of the transpiration, absorption, and water capacity of the cells modified by the action of the new colloidal material which may be added to the cell-masses. It is notable, however, that at some time approaching midday the pen recording the variations in volume traces a line not far from the horizontal for a brief period, perhaps half an hour, at which time absorption and transpiration balance, and the absolute water capacity of the cell-masses is greatest (see figs. 28 and 29). An equally marked confluence of fac-

TABLE 106.

Time.	Weight in grams.	Increase in grams.	Percentage increase.
5 <sup>30</sup> a. m...	23.62	.....	.....
6 30 a. m...	25.25	1.63	6.9
4 30 p. m...	22.25	.....	.....
5 30 p. m...	25.00	2.75	12.4

tors is to be seen late in the afternoon, with lessening water capacity, minimum acidity, and the beginning of decreased absorption by the root-system.

Some measurements of growth and hydration of the *Platyopuntia*, the growth of which has been observed so extensively, were made by Mr. E. R. Long in 1915. Imbibition was tested by noting the increases

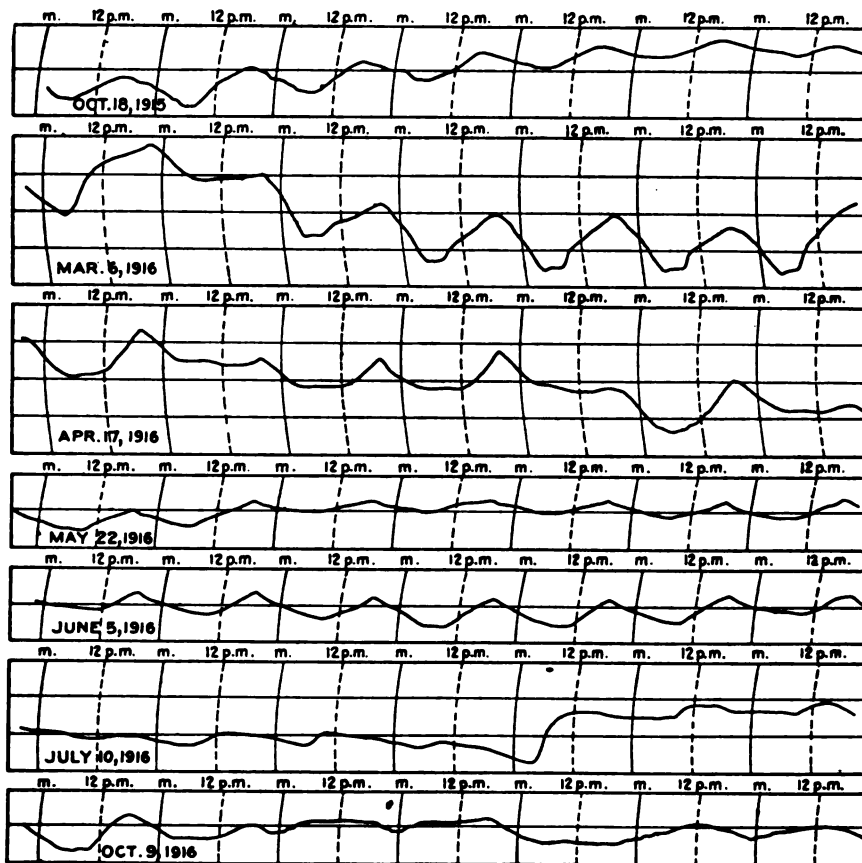

FIG. 28.—Portions of auxographic record of variations in length of a joint of *Opuntia* from October, 1915 to October 1916. The joint had formed roots which depended in a glass jar of tap-water and the joint was held firmly in a natural erect position. The preparation stood in the south end of a glass house and was exposed to the alternations of sunlight and darkness with accompanying temperatures as low as 8° C. in the morning and as high as 45° C. in midsummer afternoons. The actual variations are amplified 30 and elongation is denoted by the downward movement of the pen. Divisions of scale = 1 cm. The joint was in a stage of completed growth during the week beginning October 18, 1915, at which time elongation occurred from evening until the middle of the forenoon, and shortening during the remainder of the day, with the length less at the end of the week than at the beginning. The records for March and April show a similar daily periodicity, but with an increase in length which may be ascribed to imbibition under the advancing temperatures. The daily losses and gains are more nearly equal in May and June and the variations of narrow amplitude. Some loss is shown in July and the reactions of the joint a year from the beginning of the record show a daily variation different in many particulars from those of the previous year. See figure 29 for a continuation of the record.

in weight of disk-shaped sections taken from the joints at sunrise and sunset, with the results shown in table 106. (Fig. 30.)

These results afford a comparison only between conditions at the beginning and end of the daylight period and the time of the maximum and minimum imbibition capacity was not determined as in *Mesembryanthemum*. (See p. 145). Mr. Long also tested the effects of acids, hydroxids, and salts upon the growth of *Opuntia*. Preparations for this purpose consisted of mature joints bearing young flower-buds. The bases of the joints were suspended with their freshly cut surfaces in solutions in glass jars, and the lengths of the buds were taken at intervals of 3 or 4 days. The final amount of growth in each case is given in table 107. (Fig. 31.)<sup>1</sup>

TABLE 107.—Growth of flower-buds of *Opuntia*, March 25 to April 24.

Medium.	Total growth increment before flowering.	Time.
Distilled water.....	42.0	27
N/50 NaOH.....	40.5	30
N/50 malic acid.....	36.0	28
N/50 HCl.....	31.0	28

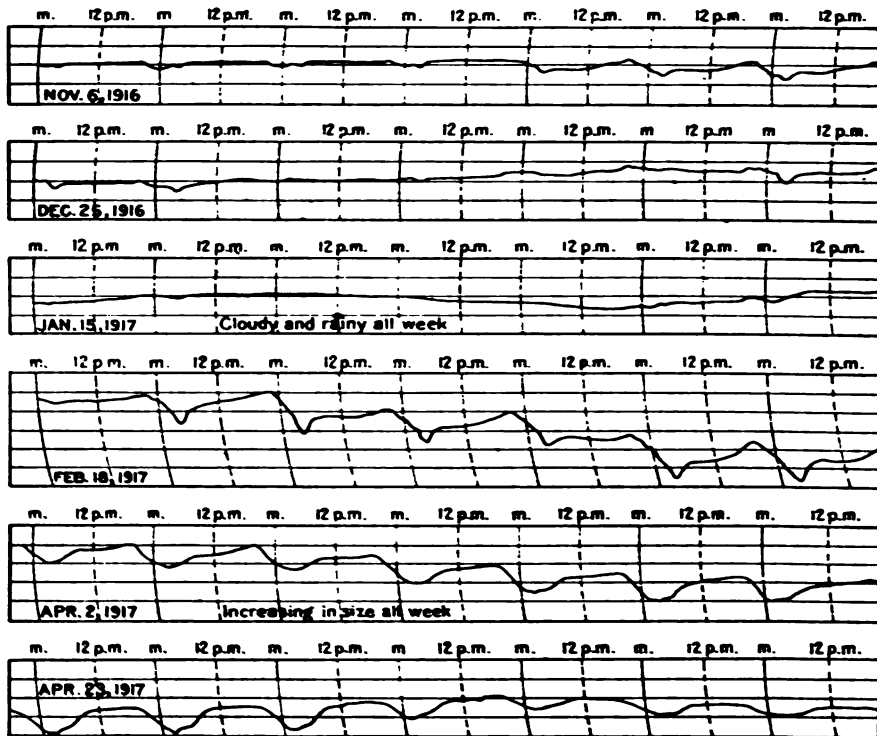

FIG. 29.—Continuation of record of variations in length of mature joint of *Opuntia* (see fig. 28) amplified 50 times. The amplitude of the daily variations has been reduced to a minimum November to January, with a general shrinkage in length. Equable conditions accompanying clouds and rain are illustrated by the record of the week beginning January 15, 1917. The influence of the advancing temperatures in inducing increased imbibition is illustrated by the records of February to April, and a balance of daily losses and gains occurred about the end of April.

<sup>1</sup> Long, E. R. Growth and colloid hydration in cacti. Bot. Gaz., 59: No. 6. 1915.

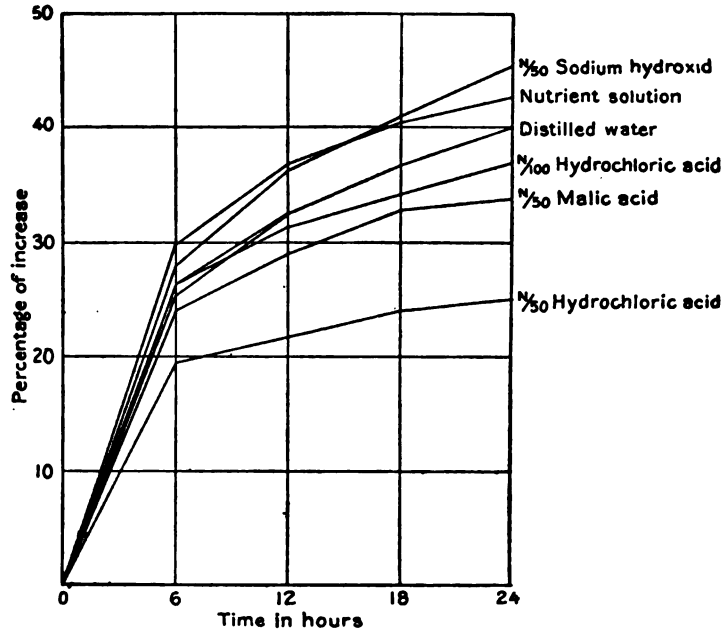

FIG. 30.—The course and amount of swelling of sections of *Opuntia* in solutions as indicated during a period of 24 hours. Fresh sections 12 mm. across were cut from green joints and placed in glass dishes in a dark room at 18° C. The lines are traced from the results of measurements made at 6-hour intervals. Compare with fig. 31. (Redrawn after E. R. Long.)

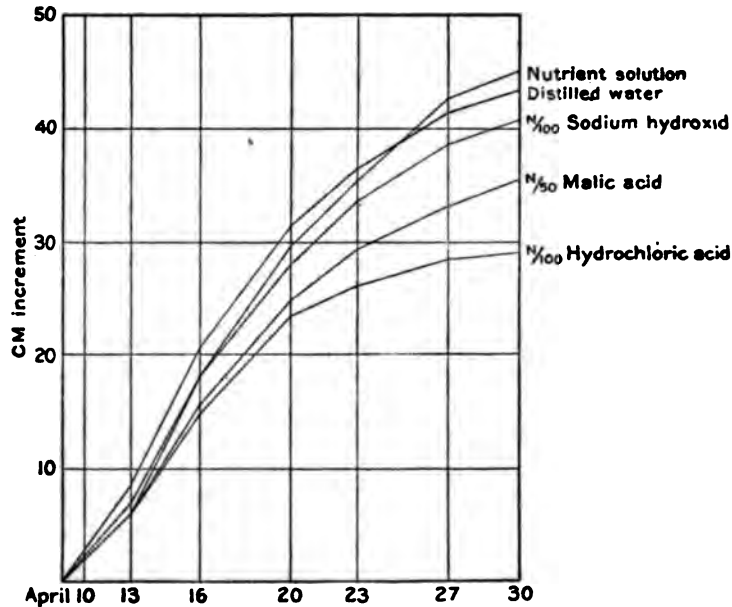

FIG. 31.—Record of growth of flower-buds of *Opuntia*, on joints the bases of which were immersed in solutions, the imbibition effects of which are shown in fig. 30. The record covers a period of three weeks, or the entire measurable period of extension of the buds to the time of opening. The preparations stood in a glass house and were exposed to alternating conditions of daylight and darkness and to temperatures of about 15° to 30° C. (See fig. 30.) (Redrawn after E. R. Long.)



Mr. Long's results were confirmed by the author in April 1918, at which time auxographic methods and technique of measuring the swelling of such sections had been brought to an advanced stage of efficacy. Sections were cut at sunrise, noon, and sunset, from young joints 8 to 10 cm. long growing in the open under natural conditions. Such sections had an average thickness of about 4 mm. and when swelled at 20° C. gave the increases shown in table 108.

TABLE 108.

Opuntia, median sections.	Time taken.				Dried slice taken 7 a. m.
	7 a. m.	8 a. m.	Noon.	5 p. m.	
	<i>p. ct.</i>	<i>p. ct.</i>	<i>p. ct.</i>	<i>p. ct.</i>	
Distilled water....	7	4.6	8.2	4.6	392
Citric acid.....	6	6	8.2	5.2	400
Sodium hydroxid..	.....	8.2	12.0	11.8	440

The great increase of dried slices is indicative of high water capacity of living material. The relative swelling of the sections in the different solutions is identical with that of the fresh sections, demonstrating that the dominant process is imbibition rather than osmosis.

The time required for satisfaction varied widely with the time at which material was taken and the character of the solution. The sections taken at the end of the day were fully hydrated in distilled water and began to shrink in 6 hours. The sections taken at sunrise, which were most highly acid, as those taken in the evening are least acidified, were satisfied in 2 hours and began to shrink in 3 hours. The material taken in the morning was saturated in the acid solution in less than an hour and was shrinking rapidly an hour and a half after

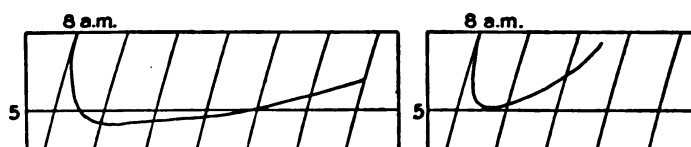

FIG. 32.—The tracing on the left shows the variation in volume of a trio of sections of a young joint of *Opuntia* 4.6 mm. in thickness which swelled 6.5 per cent in citric acid, 0.01 N, less than three hours at 20° C., then began to shrink. The tracing on the right shows the reaction of a similar trio which had an average thickness of but 3.9 mm., and which swelled 6.4 per cent in an hour at 28° C. and then began to shrink very rapidly.

immersion (see fig. 32). Swelling in the alkaline solution was characteristically slow and long-continued. Material taken in the morning continued to increase for 4 hours, and that taken in the evening was still showing some increase 12 hours later.

Another feature in conformity with the condition of the joint at different times of the day was the fact, confirmed by repeated tests, that the

difference between the amount of swelling of sections in distilled water taken at sunrise and swelled at 20° and 28° C. was so small as to be negligible. The same condition prevailed in dried slices taken in the morning and dried rapidly in the desiccator. Slices which came down to a thickness of about 0.6 mm. swelled 392 per cent at 20° C. and a second set increased an equivalent proportion at 27° to 28° C. The sets of living sections used for these tests gave an increase of about 6.5 per cent in water. Sections taken at noon swelled 8.2 per cent at 20° C. and 9.8 per cent at 28° C. Sections taken at the end of the day swelled 4.6 per cent at 20° C. and 6.5 per cent at 28° C. The material used for these paired tests was selected to be equivalent as far as possible, and comparisons transverse to those stated are not allowable.

The acidosis produced by the residual acids of the morning condition may be taken to be accentuated by the rising temperature and to cancel or mask any additional absorption which might accrue as a direct effect of temperature on a neutral solution. The increases at other times would be due to the direct action of rising temperatures on absorption.

It became evident in the earliest work done with the opuntias that the young joints showed a swelling in hydroxid solutions greater than in water or acids, a fact probably attributable to the formation of compounds of the sodium hydroxid with the carbohydrates present, in conjunction with possible sodium albuminates. The carbohydrates are in greatest proportion in young joints. The swelling in hydroxid in later stages comes down to a level near that in acid and in water.

An additional fact of interest was the action of the juice of the joints taken in the condition in which it is found at midday. Duplicates of the dried slices, which have already been noted as showing an increase of 390 per cent in distilled water, swelled 325 per cent at 20° C. in the expressed juice. Similar dried slices swelled 372 per cent in the freshly expressed juice of *Echinocactus wislizeni*. Its hydrating effect on thin plates of a biocolloid consisting of agar 6 parts, opuntia mucilage 2 parts, bean protein 1 part, and gelatine 1 part was much marked. Such sections swelled 2,450 per cent at 20° C. in distilled water, and only 700 per cent in the fresh juice of *Opuntia* taken at midday.

The principal factors which influence the rate and course of growth of *Opuntia* have been described in the preceding pages. The joints when in the youngest stage have a mode of growth which does not differ materially in the record which it makes from that of many other green plants. As soon as it reaches medium size its innate peculiarities of transpiration and metabolism and certain morphological features operate to give it a highly characteristic daily chart of elongation and retardation or shrinkage. The respiration of these plants is of a character which results in the accumulation of acids to an amount equivalent to as much as 0.1 N malic acid at daybreak, which is suffi-

cient to have a distinct effect on the hydration capacity of the cell-colloids. Late in the daylight period the acid may be reduced to a point below the hundredth normal which has been used so extensively in this work as a standard solution. The effects of acidosis would, of course, vary as the composition of the pentosan-protein-salt colloid of the joint passed from its embryonic aspect to that of the mature member. The actual amount of water lost by the greater number of plants, especially those with thin stems and broad leaves, is greater for the daylight period than for the night. *Opuntia* is a notable exception to this generalization, and its rate of transpiration is greatest during the night, usually between midnight and morning. All of these agencies affecting imbibition likewise have a determining influence on growth, and the resultants in *Opuntia* and presumably in other massive succulents are such as to constitute a characteristic type of growth.

Another feature about which but little has been said is that of the morphology of the compound members of the stems of *Opuntia*. At first, when a young joint is but 2 or 3 cm. in length, it is wholly in an embryonic condition and its colloids show the reactions of such mixtures. As development progresses much permanent tissue is formed, in which finally the embryonic tracts lie as a network or reticulum. Any given section of a growing joint contains growing and mature tissue after a certain stage is reached, but when the mature tissue reaches a proportion something greater than that of the growing masses its characteristic variations in hydration overshadow those of the growing cells and give rise to the retardations and shrinkages which are so marked a feature of these plants. It is probable that many features of the rate and course of growth may be ascribed to anatomical relations, of which the above is an illustration.

## XI. THE HYDRATION REACTIONS AND GROWTH OF MESEMBRYANTHEMUM, HELIANTHUS, AND PHASEOLUS.

The results obtained by a study of the hydration of the cacti are especially valuable because of the possibility of their correlation with features of varying composition which could be determined by chemical analyses. Measurements of a second type of succulent were sought for the purpose of bringing into relief the possibilities of rapid changes in the water-content of growing and mature organs. A mesembryanthemum (*Mesembryanthemum edule*) which flourishes in the open at the Coastal Laboratory and in the glass-house at the Desert Laboratory furnished material suitable for such studies. The leaves attain a length when mature of about 6 to 10 cm. and are triangular in cross-section, the three faces being about 10 to 12 mm. across. Metabolism runs a course in these organs similar to that of the opuntias, as a result of which acid accumulates during the night, and decreases with the disintegrating action of light during the daytime, as illustrated by the data given in table 109. The total daily range in the concentration of the acids is much less than that displayed by the cacti.

TABLE 108.—Acidity of juice of leaves of *Mesembryanthemum* in cubic centimeters of N/100 KOH.

	8 a. m.	Noon.	4 <sup>h</sup> 30 <sup>m</sup> p. m.
<i>Sample A.</i>			
Fresh juice, per c.c. . . . .	p. ct. 0.0280	p. ct. 0.0279	p. ct. 0.0232
Total acidity per gm. dry material. .	1.584	1.509	1.191
Total acidity per gm. fresh material.	.0356	.0351	.0264
<i>Sample B.</i>			
Pure juice, per c.c. . . . .	.0273	.0225	.0205
Total acidity per gm. dry material. .	1.072	1.091	1.056
Total acidity per gm. fresh material.	.029	.0241	.0275

Measurements of the varying diameter of young and of mature leaves indicate that the direct water-loss from the surfaces are so important as to mask the imbibition capacity as affected by acidity and other factors, as will be apparent from auxographic measurements.

Mention has been made previously of the general similarity of the course of growth of *Mesembryanthemum* to that of *Opuntia*. It was possible to go into this matter in greater detail in the experiments described in this volume.<sup>1</sup>

A series of tests was arranged to ascertain the alterations in volume of these leaves both in a mature condition and when in the course of

<sup>1</sup> MacDougal and Spoehr. Growth and imbibition. Proc. Amer. Phil. Soc., 56: 314. 1917.

growth. Their regular surfaces made it possible to place one side snugly on a small wooden block, and to bring the cork-tipped vertical auxograph lever in bearing with the uppermost angle of the leaf. The stem was held firmly a few centimeters from the base of the leaf, which was exposed to no disturbing conditions (fig. 33). First, the diurnal variations of a mature leaf were followed without any attempt being made to equalize temperatures, which were taken by a thermometer with a thin bulb thrust into a second leaf and allowed to remain there. The readings were as low as 10° C. at daybreak and as high as 31° C. at midday. The variations in volume amplified 45 times shown in figure 34. The record beginning at noon on February 14, with the temperature of the leaves at 25° C., was at a juncture when shrinkage set in, lessening the thickness of the leaf about 1 mm., or 10 per cent of its turgid thickness before 5<sup>h</sup>30<sup>m</sup> p. m., at which time, with the temperature still at a high point (27° C.), the shrinkage came to an end and enlargement began, which continued through the night, so that at 8 o'clock the following morning the leaf was actually thicker than on the preceding day. The temperature on this day rose to 31° C. and the shrinkage exceeded that of the preceding day, amounting to about 13 per cent of the turgid thickness of the leaf. Swelling began again in the evening, which restored the leaf to about its original dimensions 48 hours after the beginning of the record.

The variations appeared to run parallel in part only to those already described in detail for *Opuntia*, and to the extent that the daily variations take the form of alternate shrinking and enlargement with the increase in excess of the loss. The chief features of growth may be illustrated by the record of one of a pair of leaves which had attained about two-thirds of the full size. This was put in bearing with the auxograph in the

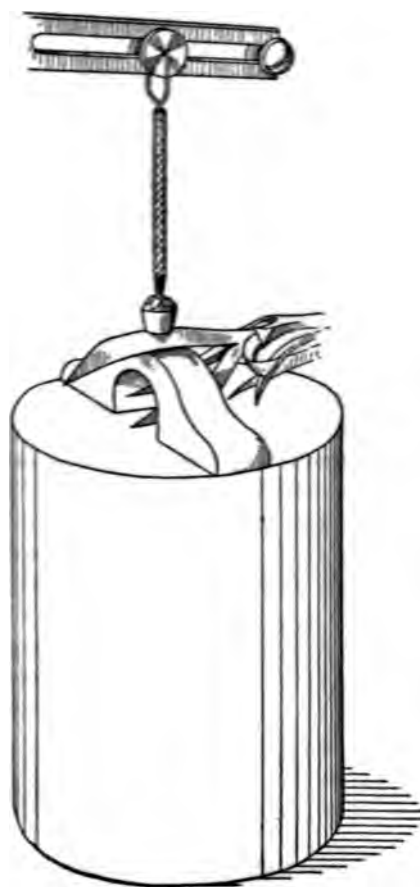

FIG. 33.—Detail of arrangement of auxograph to record variations in thickness of leaf of *Messembryanthemum*. Leaf in a horizontal position resting on a wooden support cut away below to make place for the younger terminal leaves.

manner described, and a portion of the record is given in figure 35. As may be seen, the period of shrinkage, which begins about the same time in the older leaf, continues for a shorter period, on some days not more than 2 hours, and enlargement sets in in mid-afternoon. The thickness on each successive morning was greater than at the same time on the preceding day, demonstrating that actual growth was in progress.

Two series of measurements were now undertaken to secure new records of the elongation of leaves which had reached about half the final length and of others still younger. Such a pair of young leaves, with their surfaces still appressed in an erect position, were brought into bearing on an auxograph lever in a sunny place in a glass-house. The length of the exposed portion was about 25 mm. and their thickness was not over 0.5 mm. at the beginning of the tests. Here, as in previous preparations, it was found that whatever the causes of the stoppage of growth and of shrinkage might be, they were not effective in producing an actual cessation of elongation, which in these young leaves continued throughout the 24 hours of the day variously responsive to alterations in temperature (fig. 36).<sup>1</sup>

Another pair which were about to spread by the growth of the bud ensheathed between their bases were attached to the auxograph and set in a place where they would be shielded from the direct rays of the sun. Preparations of all three stages increased in length and thickness

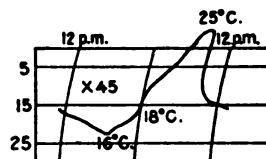
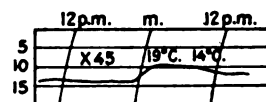

FIG. 34.—Upper part of figure is an auxographic record of variations in thickness of leaf of *Mesembryanthemum* on a cloudy day with but little change in temperature, as taken by a mercurial thermometer from a similar leaf. Upward course of line denotes increase.  $\times 45$ . Lower figure is an auxographic tracing of same leaf on sunny day with temperatures of 16° to 25° C. Shrinkage occurred during the entire daylight period.  $\times 45$ .

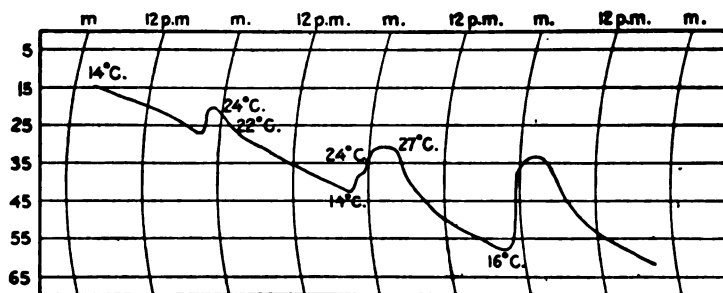

FIG. 35.—Auxographic record of thickness of pair of leaves about half mature size.  $\times 45$ . A daily shrinkage between 8 a. m. and midday occurred, which amounted to an increasing proportion of the increase taking place during the remainder of the day.

during the entire night, the increase in thickness being very rapid during the first half of the night and slowing down to a very low rate

<sup>1</sup>MacDougal and Spoehr. Growth and imbibition. Proc. Amer. Phil. Soc., 56: 310. 1917.

afterward, beginning actual shrinkage by 9 a. m. Growth of the leaf of middle age slows down with the low temperature of daybreak, but accelerates at 9 a. m., at the time the older leaf begins shrinking, at 17° C. The youngest pair of leaves grows with a high rate all night, with a perceptible slowing at daybreak, but it also accelerates at 9 a. m. with the rising temperature, at the time the oldest leaves are shrinking (fig. 37).

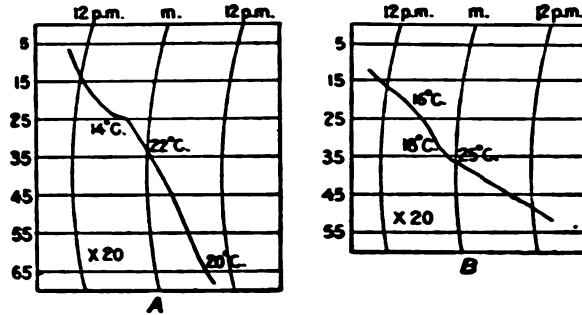

FIG. 36.—A, autographic record of elongation of pair of leaves 2 cm. long during a 24-hour period; temperatures of 14° to 25° C. Retardation during period of highest temperature is illustrated. X20. B, action of same leaves in shade.

The general features of growth under the usual varying conditions of alternating daylight-high temperature and night-low temperature complexes being determined, it became necessary to test the swelling of the leaves, as had been done with the joints of *Opuntia* to ascertain their unsatisfied hydration capacity.

Preparations for testing the swelling of living material of leaves were made by placing these triangular organs on a flat surface alongside a guide of 5 mm. in thickness. A razor slid along this slices away the uppermost angle, leaving a truncated section 5 mm. in thickness, in which the central fibrovascular tissue could be seen through the translucent parenchymatous tissue. Segments about 1 cm. long were taken, to the exclusion of the basal and apical parts of the leaf. It is to be noted that active enlargement is usually in progress morning and evening in young leaves, while mature leaves are enlarging in the morning but shrinking in the afternoon and night. The results of the hydrations are shown in table 110.

In the above tests the amount of swelling was most in distilled water, less in hydroxid, and least in acid, in mature leaves taken in the even-

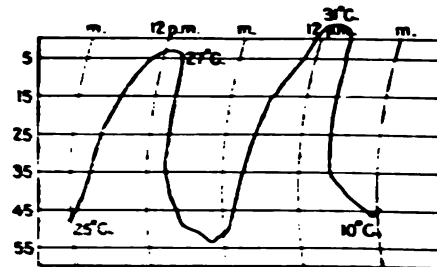

FIG. 37.—Variations in thickness of a mature leaf of *Miconia*. X45. Temperatures taken from a similar leaf with a mercurial thermometer.

ing while in a shrinking stage. These differences hold for the morning, except that the effects of acid and hydroxid are about equal.

TABLE 110.

Mesembryanthemum, median slices of leaves.	Taken at 6 p. m., swelled at 15 to 17° C.		Taken at 8 a. m., swelled at 13 to 15° C.	
	Mature leaves.	Young leaves.	Mature leaves.	Young leaves.
Distilled water.....	<i>p. ct.</i> 18	<i>p. ct.</i> 12	<i>p. ct.</i> 13	<i>p. ct.</i> 22
Sodium hydroxid, 0.01 M	16	16	8	13
Citric acid, 0.01 N.....	15	12	8	47

An additional set of measurements with young leaves decreased the differential between the more acid condition of the morning and the less acid condition of the evening, as is shown in table 111.

TABLE 111.

Mesembryanthemum.	Young leaves, taken at 6 p. m., and swelled in darkness at 12 to 15° C.	Young leaves, taken at 8 a. m., and swelled in darkness at 12 to 15° C.
	<i>p. ct.</i>	<i>p. ct.</i>
Distilled water.....	13	12
Sodium hydroxid, 0.01 M..	11	10
Citric acid, 0.01 N.....	11	10

Young leaves are generally in a state of enlargement both morning and evening, and should show but little difference in swelling capacity in the two stages, while mature leaves are enlarging in the morning and shrinking in the afternoon, in expression of a condition which is reflected in the swelling reactions. Thus, for example, sections of mature leaves taken in the morning, which had a thickness of about 9.3 mm., swelled 6 per cent at 14° to 19° C. in the dark room, which was about the temperature at which they were taken. An equivalent set taken at 1 p. m. swelled 15 per cent in water at 17° to 19° C. From which it may be seen that the measurements of variations in thickness of entire leaves (see pp. 147, 148) are in entire conformity with other known facts.

The foregoing measurements were obtained from segments cut from leaves about 1 cm. in length and with the epidermis on the three faces intact. The measurements made for the purpose of determining the possible effects of acidity were obtained by cutting slices which removed one angle of the leaf and the epidermal face parallel to the excised surface. If the water-loss is a factor, its effects would be most



pronounced in the layers which had been removed. The mature leaves were distinctly flabby to the touch and the external layers were in a state of partial collapse during the midday period.

Segments of young leaves in the stage in which these organs continued elongation and increase during the entire day were now taken for comparison. Their thickness was a little more than half that of the mature leaves. The trio of sections taken from leaves at 8 a. m., when the highest turgidity prevailed, showed a swelling of 13.6 per cent, while those taken at midday swelled 16.7 per cent at 14° to 20° C. The difference in the two cases is much less proportionately than that which is set up in mature leaves and fully accounts for the shrinkage of the older organs. Beyond this the auxographic tracings made obvious another difference between the young and mature leaves. The total swelling in the mature leaves was reached in 6 or 8 hours, most of which developed within 2 hours of immersion. The swelling of young leaves was much more gradual, and the rate was less rapid at first and then decreased much more gradually and had not actually ceased at the end of 20 hours. The material in the young leaves was not only alive, but in a growing condition; consequently new colloidal material in the process of aggregation would provide a continuing source of hydration capacity.

Confirmatory evidence consists in the fact that when two pairs of leaves are put in bearing with auxographs, the one exposed to the sun soon reaches the stage where the water-loss at midday is equivalent to growth and neutralizes it on the record, while the pair of leaves of the same age shaded from the sun continues elongation scarcely checked or retarded during the same period. Now, if the preparation in the sunny location experiences a cloudy day or is shaded, it too continues growth during the entire day in a manner which shows conclusively that the daily retardation is in the main due to excessive water-loss in the case of the *Mesembryanthemum*. A similar action by the cacti has already been discussed in Chapter X.

The practice of testing the swelling of dried sections for comparison with that of living material was followed as in *Opuntia*. Sections of living leaves about 5 mm. in thickness were prepared as above, and these were placed between folds of filter-paper and weighted only sufficiently to prevent warping and curling during desiccation, which continued for a week. Their final thickness was about 0.25 mm. and their swelling, unlike that of the segments of *Opuntia*, did not come back to the approximate size of the fresh material. The final measurements in percentages of the dry thickness were as follows:

TABLE 112.

	p. ct.
Distilled water.....	100
Citric acid, 0.01 N.....	120
Sodium hydroxid, 0.01 M.....	100

It had been previously concluded that the dominant factor in the varying rate, and in producing shrinkage, was that of modified hydration capacity as dependent chiefly upon the acidity of the sap and the balance between absorption and water-loss by transpiration. The effects of the last-named feature were marked, as the experiments were carried out under conditions of drought approaching the limit of endurance of this plant. Sudden changes in hydrogen-ion concentration of the sap of another species of this genus, with other unusual features of the sap as noted by J. Hempel, may be responsible for some of the aberrances shown by this plant.<sup>1</sup> While this author gives nitrogen determinations showing much greater uniformity than in other succulents, this uniformity of total nitrogen may include many changes in amino-groups which might affect the water capacity of the colloids. One species was found especially high in nitrogen.

The sunflower has been used extensively in studies on growth-rates, and the behavior of young and older internodes of the same stem of *Helianthus* furnishes some homologies with the alterations exhibited by the succulents. A stock of *Helianthus annuus* was grown in the glass-house of the Desert Laboratory in February and March 1918, at which time they showed vigorous and normal development. During most of the time in which these observations were made the temperature of the air rose to 25° to 31° C. in the glass-house and some slight wilting effects were noticeable in the leaves at midday, a fact included in the records given below, to which are also attached the temperatures taken by thermometers thrust into the stems. The young parts in which growing cells constitute the greater part of the mass continue to increase during a period in which the older parts are shrinking. The older parts consist of cylinders of tissue, almost mature, fully saturated, with no continuing increase in hydration capacity; and the growing cells are in the form of an irregular cylindrical shell underneath the epidermis, the thickness of which is no more than a small fraction of the entire diameter. Consequently the external measurements of the stem are chiefly determined by the changes in the mature cell-masses.

The preliminary swelling tests were made with sections of the terminal internodes from which tangential slices had been removed, leaving them with a thickness of 2.7 mm. Such sections at 14° to 16° C. swelled 7.4 per cent in distilled water, 9.2 per cent in hundredth-normal sodium hydrate, 5.5 per cent in a similar solution of citric acid, and 7.4 per cent in a similar solution of potassium nitrate. These results are fairly representative of this type of plants.

The preceding series was made up before the daily shortage of water in the terminal parts of the stems had been detected. A second set of

<sup>1</sup> Hempel, J. Buffer processes in the metabolism of succulent plants. Compt. Rend. d. Trav. d. Lab. d. Carlsberg, 13. 1917. See pp. 45-51.

sections were therefore taken at 1<sup>h</sup>30<sup>m</sup> p. m., when the plant stood at a temperature of 22° C., and these were swelled in the dark room at once with solutions which stood at 18° to 20° C. during the time of the swelling. The increases were as follows:

TABLE 113.

	<i>p. ct.</i>
Distilled water.....	70
Citric acid, 0.01 N.....	19
Sodium hydroxid, 0.01 M.....	46
Potassium chloride, hydrochloric acid, 0.01 M.....	14

The examination of the sections after the records were complete showed that they were variously twisted and curled, due to the fact that the internal parenchymatous tissues had swelled more than the external layers. So far as could be estimated by simple observation without measurement, the error did not double the measurement, however. Consequently it is to be seen that the imbibition capacity of these stems, due to a depletion of the water-balance, is much greater at noon than in early morning.

A repetition of the first test with whole sections that could not so readily twist showed that another series of sections taken at 8 a. m. swelled as follows, at 18° to 20° C.:

TABLE 114.

	<i>p. ct.</i>
Distilled water.....	4
Citric acid, 0.01 N.....	4
Sodium hydroxid, 0.01 M.....	6.5
Potassium chloride, hydrochloric acid, 0.01 M.....	6

This series was characterized by the satisfaction of the full hydration capacity within an hour or two, except in the case of the alkaline solution, in which the increase was very gradual. The material had returned to its original dimensions within 6 hours in the other liquids and continued to shrink. This action, coupled with decoloration, was especially marked in the acidified saline solution. As a still further verification of the above results, a trio of sections exactly like those of the above series were taken at midday on the following day, and these swelled 14 per cent in water, while another trio increased 10 per cent in the acidified saline solution before shrinking.

The earlier measurements of the swelling of the sunflower having been made with the terminal internodes of growing stems, a final series was made in which were used the cotyledonary stalks from which the plumules had been cut a day or two earlier. Measurements as follows were obtained at 17° to 19° C.

TABLE 115.

	<i>p. ct.</i>
Distilled water.....	6
Citric acid, 0.01 N.....	4
Sodium hydroxid, 0.01 M.....	7
Potassium chloride, hydrochloric acid, 0.01 M.....	7

Another trio of sections from an older stem measuring 5 mm. in diameter was taken at midday, and when immersed in distilled water at 21° C. increased 7.5 per cent. The entire lot of observations confirms and supports the conclusion that the stems of *Helianthus* have their hydration capacity more nearly satisfied in the morning than at noon, when the leaves may be in a wilting condition. This fact would inevitably have an important influence on the rate at which such stems might elongate.

The growth of stems of *Helianthus* was measured on stems growing in the soil of a large bed. Heavy wooden bases were placed on the surface of the soil of the greenhouse bench and the stems were brought closely against this and fastened at the base of the growing internodes in such manner that only the elongation above this point would be registered by the auxograph, and the movements of the base due to softness of soil or other features would have no effect. The growing part consisted of one internode approaching maturity and a terminal one less than 3 cm. in length. A fine wire loop was passed around this and carried up over the arm of the auxograph lever.

Temperatures were taken by thermometers with thin bulbs thrust into the stems of similar plants within a few centimeters of the one being measured. As an example of the rate, the older and the younger internodes, together having a length of about 15 cm., increased 2.7 mm. during an hour at midday at a temperature of 30° C., while in the 2 hours immediately afterwards, when, as will be seen, the stem of another plant was showing shrinkage in thickness, the rate was but 1.2 mm. per hour at 29° C. During the next 4 hours the temperature slowly fell to 19° C., but the rate of elongation came up to 2.1 mm. per hour, a fact plainly due to decreased water-loss.

A similar behavior ensued on the following day, when the rate was 2.4 mm. per hour at midday at 29° to 30° C., then fell off to 1.4 mm. per hour during the next two hours at 26° C., and then to 0.6 mm. per hour during the following 2 hours. Such diminished growth might be attributed to the falling temperature if it had not been observed that a higher rate was shown at temperatures as low as 14° to 16° C. This lowered rate in the afternoon was accompanied by a distinct wilting of the leaves.

An auxograph was now provided with a cork bearing hollowed to fit against a stem about 15 cm. from the apex, and the stem was held firmly in place, so that any variation in thickness would be expressed by the free arm of the auxograph and traced on the revolving cylinder by the pen. The daily action may be exemplified by the following transcript from the notebook:

"Feb. 8. The temperature had risen from about 16° C. in the morning to 23° C. at 10 a. m., at which time an increase in the thickness of the stem at a point 15 cm. from the tip had been in progress for 4 hours. The pen was

stationary at midday, with a stem temperature of 26° to 29° C. Actual shrinkage now began and continued through the afternoon, but all action ceased at night. On the following day swelling or increase in thickness began at 8 a. m. at a temperature of 12.5° C., but continued for an hour only. The leaves were beginning to flag at 10<sup>h</sup>30<sup>m</sup> a. m., as the plants had not been watered, and shrinkage was in progress before noon at a temperature of 23.5° C." (See fig. 38.)

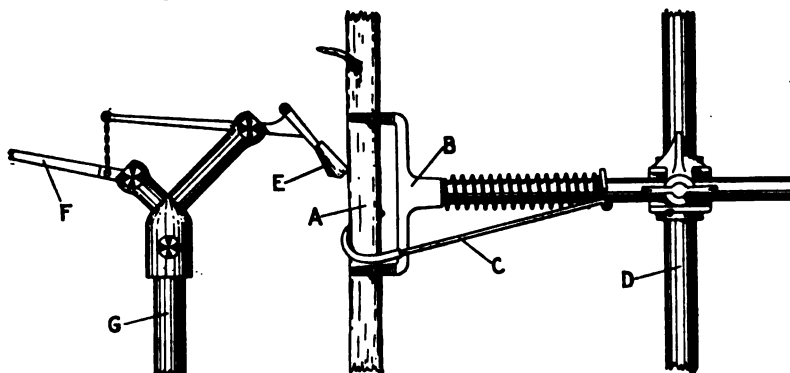

FIG. 38.—Detail of arrangement for recording variations in thickness of stem of *Helianthus*. A, stem; B and C, parts of clamp holding stem rigidly in place; D, support; E, cork bearing of short lever of auxograph; F, pen arm of auxograph, and G, rack-and-pinion column of auxograph.

A second preparation was set up on February 10, in which the variations in thickness were taken at a place but 6 cm. from the tip of the stem. The adjustment had been completed by night and an increase in thickness of 0.38 mm. took place in 12 hours at temperatures between 24° and 18° C. Constant readjustment was necessary to obtain reliable measurements, and on February 12 another record was obtained, at which time an enlargement of 0.4 mm. was recorded between 11 a. m. and 2<sup>h</sup>30<sup>m</sup> p. m. at temperatures of 22° to 25° C. After this time a slight shrinkage occurred, although the plant was so well supplied with water as to show no indications of wilting. Here, as in the leaves of *Mesembryanthemum*, elongations may be taking place at a lessened rate in the extreme terminal part of a stem in which the hydration capacity is kept continuously higher than in older internodes, while at the same moment an actual decrease in thickness may be taking place within a few centimeters of the elongating active zone. This shrinkage may ensue in a section of the stem which has not lost the capacity for elongation altogether, so that its daily record shows a period of elongation at a moderate rate during a part of the day, then a cessation due to the depletion of the water-balance.<sup>1</sup> It is obvious that the action in question is one which may be responsible for many mistaken generalizations bearing upon cessation of growth and effect of temperature on growth (fig. 39). Attempts at interpretation of the

<sup>1</sup>See Brown and Trelease. Alternate shrinkage and elongation of growing stems of *Cestrum nocturnum*. Philipp. Jour. of Science, 13: No. 6, 333. 1918.

rate and course of growth of any plant with differentiated tissues which does not take into account the mechanical composition of the organs, and especially the arrangement of the growing cell-masses with respect to mature parts, may encounter many pitfalls and can hardly fail to be inadequate.

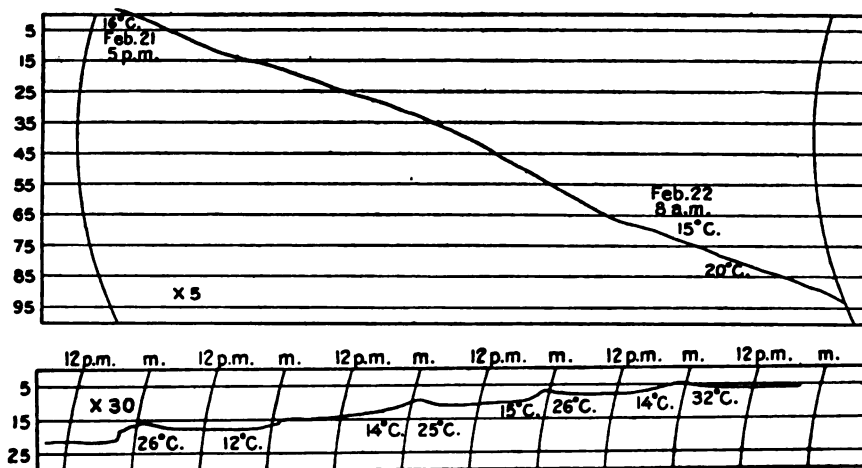

FIG. 39.—The upper part of the figure shows the course of elongation of a stem of *Helianthus annuus* for 24 hours beginning at 5 p. m., with temperatures of the plant as indicated,  $\times 5$ . Increase in length denoted by downward movement of the pen. Shown on a scale of millimeters as indicated, the total elongation during the period being 19 mm. The lower tracing shows variations in thickness of a stem of *Helianthus* 15 cm. from apex, the increase being denoted by the upward movement of the pen, with temperatures of the plant as indicated. Shrinkage or cessation of enlargement began after midday, but increase was again manifested by evening. The variation is amplified 30 times and is shown on a millimeter scale, the actual increase during six days being about 0.6 mm.

Opportunity for the measurement of growth in another type of structure was presented by the legumes of *Phaseolus* cultivated in the glass-house of the Desert Laboratory in April 1918. These pods are first measurable when they have attained a length of about 3 cm. and a thickness of 2 mm., and as they attain a final length of 10 to 12 cm. in a week, the rate is rapid enough to afford ready means of detecting variations and connecting them with possible modifying agencies. The thickness of a mature pod through a full-sized bean may be as much as 6 to 8 mm. The imbibition or swelling capacity of the entire structure and its contents was tested at two different stages. The measurements of this capacity in the earlier stage was made upon sections of the pod less than a centimeter in length, which, by their bulging contour, showed the presence of an embryo bean inside, although this was much less than a millimeter in diameter and probably played a very small part in the swelling. The increases of such sections at two different temperatures were as noted in table 116, the average thickness of the trios of sections being 2.7 to 2.8 mm.

It will be seen by reference to the records of growth cited in table 116 that the higher temperature lies above the point at which the most rapid elongation or thickening takes place, a matter which might be due to excessive water-loss or to the action of residual acids at high temperatures.

TABLE 116.

Swelling of bean pods.	18° C.	38° C.
	p. ct.	p. ct.
Distilled water.....	2	2.7
Citric acid, 0.01 N....	2	Shrinkage.

TABLE 117.

Swelling of beans.	15° C.	38° C.
	p. ct.	p. ct.
Distilled water.....	11	10.6
Citric acid, 0.01 N....	10.4	5.5

Beans nearly mature but still in the process of enlargement were removed from green pods, the ends of the cotyledons cut away, and then a slice removing the hypocotyl; the remainder of the cotyledons came away free from the outer coating or membrane. The average diameter of trios of such sections was 3 to 3.2 mm., and their swelling was as given in table 117.

The amount of hydration was less at the higher temperature in distilled water, suggesting that the point of maximum imbibition or swelling lies below 38° C. In the presence of acid the amount of water absorbed is distinctly less than at 18° C. These data being available, attention may now be profitably turned to the features of enlargement of the pods.

Preparations were made by which delicately weighted auxographs recorded the variations in thickness of pods in the stage when about half the final length had been reached. The end of the bearing-lever rested over an enlarging bean, and variation during a week is shown in figure 40.

The localization of growth had been previously determined by the well-known expedient of marking a young pod which was in the stage of initial growth of the young beans into four 1-centimeter intervals (fig. 41). Swelling tests had been made of the pods in this stage (table 116). Ten days later the basal and apical intervals had increased to 2.5 cm., while the other two had each elongated to 4 cm. All measurements of variations in thickness were made in this median region of maximum elongation (fig. 42).

Growth both in length and thickness of the young pods was at the lowest rate at night, during which period the temperature was at 15° C.

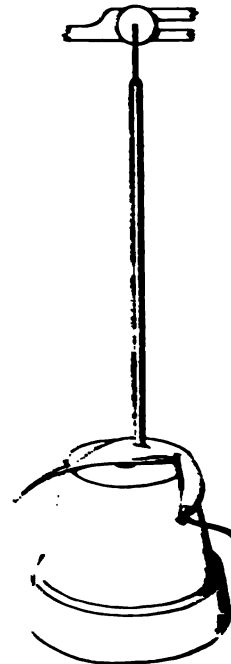

FIG. 40.—Arrangement of vertical lever of auxograph making record of variations in thickness of growing bean and pod.

or below. As the temperature of the air rises above this point in the morning, acceleration ensues and a high rate prevails until the thermometer shows 25° C. or above, at which time retardation takes place, which may continue to complete cessation or even shrinkage. It was noted that the behavior with respect to the temperature in this region might be modified by varying the conditions of water-loss, and that growth might be maintained at a higher rate if high humidity around the growing member is maintained. As the temperature falls at the

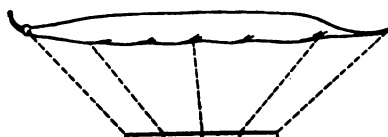

FIG. 41.—Diagram showing the elongation of four 1-cm. intervals into which a young pod was divided. Maximum increase ensued in third centimeter from base.

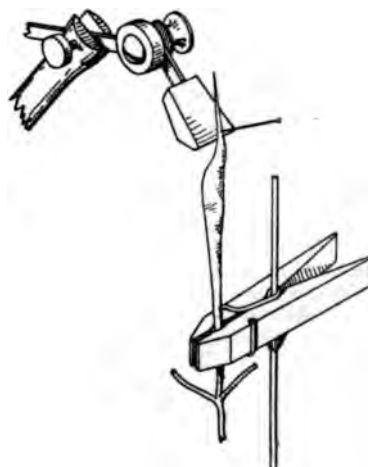

FIG. 42.—Arrangement of auxograph to take variations in length of pod of *Phaseolus*. The mature tip of pod is fastened to cork buffer on end of lever of instrument.

close of the day the rate accelerates again and growth is rapid until checked by the falling temperature. (Fig. 43.)

These records were all made of plants not subjected to the direct action of the sun. One was placed in such position that the sunlight fell directly upon the pod for about 15 minutes before 6 p. m., with the

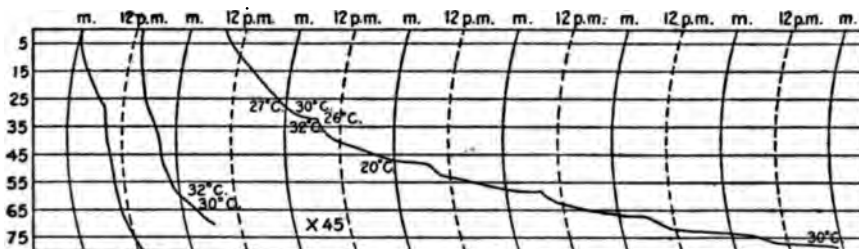

FIG. 43.—Tracing of auxographic record of growth in length of bean pod, X 45. The features of active elongation are similar to those described for variations in thickness in fig. 44. Retardation of growth is seen at temperatures above 30° C. Downward course of pen denotes increase.

result that a sudden enlargement followed, which was quickly retracted and quiescence or slow shrinkage followed. Such sudden variations have been seen in other types of organs, such as the joints of *Opuntia*, and seem to be enlargements due to expansion of gases in the organ, the cavity of the pods in this case being of such size that a marked response might be expected (fig. 44). The features of variation of



thickness are recognizable in changes in length, although the action of 120 mm. of tissue is involved as against 2 or 3 mm. in the measurements of thickness. The structural arrangement of the cell-masses and the shape of the cavity of the pod would operate to minimize the shrinkages so apparent when thickness is measured.

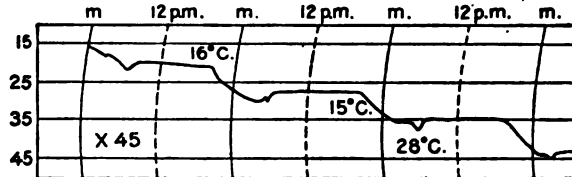

FIG. 44.—Tracing of an auxographic record of growth in thickness of pod of *Phaeolus*. Downward movement of the pen denotes increase in thickness,  $\times 45$ . Temperatures given are of the air near plants. The sudden shrinkage between 5 and 6 p. m. took place during a brief daily illumination by direct rays of sun. Scale ruled to 5 mm. and 12-hour intervals. Summer-time schedule. (See fig. 40 for illustration of the arrangement of auxographic levers.)

A pair of tests was now arranged in which one pod was placed inside a cell consisting of a short section of a glass T-tube of about 1 cm. internal diameter. The pod was placed in a horizontal position in the main section of this tube, which rested solidly on a concrete

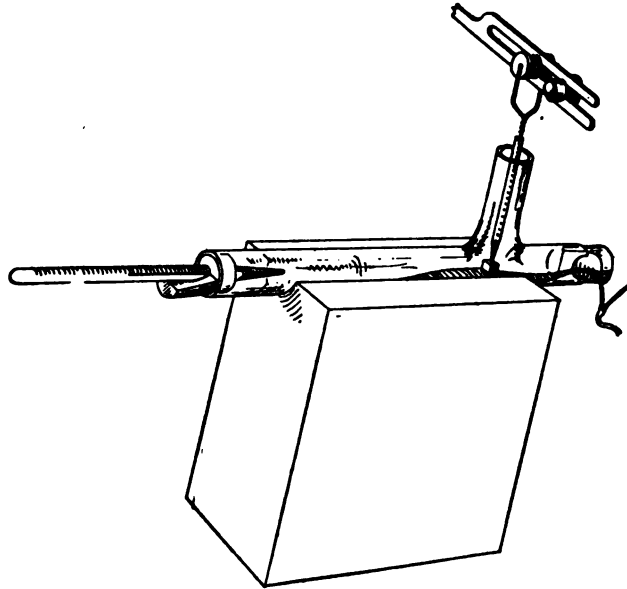

FIG. 45.—Glass chamber for controlling humidity in making auxographic record of pod of *Phaeolus*. Ends of horizontal part of chamber closed by cork stoppers fitted to stem of pod and thermometer. Tube to be closed around vertical arm of instrument with cotton wool.

block. The end around its stem was closed loosely, and the opposite end of the tube held a cork and small thermometer. The vertical arm of the auxograph reached its bearing on the pod through the upright arm of the T-tube and opportunity was given to keep record

of the temperature of the air, which in this setting must have been practically identical with that of the inclosed pod (fig. 45). The air inside this chamber was at a high degree of humidity, and it was found that the afternoon cessation or retardation of growth was not so marked in actively growing pods and that it did not come on so early in the development of the pod as in those exposed to the evaporating influence of the freely circulating air. The influence of high humidity approaching saturation was shown more directly by the application of wet slips of filter-paper in such manner that the pod was completely swathed and evaporation reduced to a minimum. This treatment was also successfully applied to pods resting upon a cork base and not inclosed in the chamber. When a slowly growing young pod was thus given an atmosphere of high humidity at temperatures from 20° to 27° C. no alteration in the rate would be visible for nearly an hour, but at the end of this time an abrupt acceleration would ensue which would continue for as much as 2 hours, and then, if the supply of moisture were not renewed, a slackening would ensue which would bring the rate back to the point at which it was growing previous to the treatment (see figs. 46 and 47).

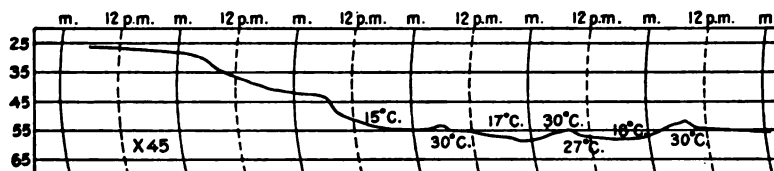

FIG. 46.—Tracing of auxographic record of pod of *Phaseolus* which was 2 mm. in thickness at beginning of record. Downward movement of pen denotes increase in thickness, X 45. The range of active growth lies between 15° and 30° C. and consequently acceleration ensued in the morning, retardation occurred as temperatures about 30° C. were reached in the afternoon, and the rate increased again at sunset, when the temperature fell to a point below 30° C., but slowing down followed in the cooler night temperatures.

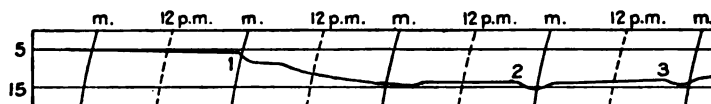

FIG. 47.—Tracing of auxographic record of variations in thickness of young pod of bean. The enlargements caused by humidity are seen at 1, 2, and 3.

The greater part of the enlargement registered in the above measurements was due to the growth of the beans, and the imbibition capacity of such seeds has been measured separately. A. Dachnowski (see reference, p. 63) found that mature seeds absorbed and held more water in acids and hydroxids than in distilled water at temperatures not given, and that the amounts taken up in alkaline solutions was greater than that in acids. The general imbibition reactions, in my own experiments, of young seeds which had reached a thickness of

2.8 mm. to 3 mm., is shown by the measurements of swellings, made at 15° to 16° C., shown in table 118.

TABLE 118.

	<i>p. d.</i>
Distilled water.....	8.2
Citric acid, 0.01 N.....	5.4
Potassium hydroxid, 0.01 M.....	12.5
Potassium nitrate, 0.01 M; citric acid, 0.01 N.....	8.2

Actually lessened imbibition took place in acid as compared with that in water; the addition of equimolecular solution of potassium nitrate to acid brought the swelling up to that in water. The total absorbed in alkali was markedly greater than in any solution tested.

The measurements of variations in length and thickness of the succulent leaves of *Mesembryanthemum*, stems of *Helianthus*, and of the pods of *Phaseolus*, and the flattened stems of *Opuntia*, yield ample evidence that the fluctuations in growth show a direct relation to the hydration capacity of the growing cell-masses, and that as a morphologically complex member or organ approaches maturity, the fully developed tissues show a varying water capacity different in many respects from that of the embryonic cell-masses. Some of the irregularities in the course of growth of internodes are due to the fact that these members include regions of embryonic tissue and tracts in all stages of differentiation approaching maturity.

## XII. WATER-CONTENT, DRY WEIGHT, AND OTHER GENERAL CONSIDERATIONS.

Two different types of organs or shoots with respect to the variations in the water-content and dry weight are recognizable in the material which has served for studies in growth as described in this volume and in the work of other writers. The commoner types of woody stems, of thin leaves, and of the organs of the greater number of the higher plants undergo a development which terminates in a mature stage in which the proportion of solid material is very much higher than that found in younger material. A parallel procedure is the prevalent one in the tissues of the higher animals. Thus, by way of illustration, Donaldson found that the proportion of water in the bodies of mammals diminishes with age, and Hatai has shown that the percentage of water is an indicator of phases of chemical alteration in the composition of the body.<sup>1</sup>

Growth and differentiation of cell-masses into specialized tissues is not inseparably connected with increases in dry weight, however, as has been demonstrated by studies of the growth of frog larvæ<sup>2</sup> in the earlier stages, and it is highly probable that similar phenomena are prevalent in the fleshy fungi and other lower forms of plants.

The distinction between the two kinds of growth has not been made previously in studies of plants, and the matter was finally taken into consideration in the experiments late in 1918. Stems of *Helianthus* and pods of *Phaseolus* illustrate the kind of material in which dry weight increases with age, upon which the greater part of all studies in growth have been carried out.

Etiolated plants furnish examples of growth with a diminished increase in dry weight. Chief interest attaches to plants which normally show such action, and the most striking illustrations are furnished by the organs of succulent plants and by fruits. The relative amount of solid material in the flattened joints of *Opuntia* does not increase with the course of development toward maturity, and joints which have reached full size may contain over 91 per cent of water. Secondary thickening, especially that which results from branching and the development of additional fibrovascular tissue, may cause an added amount to be formed. The proportion of dried material and water in the leaves of *Mesembryanthemum* does not vary greatly with age. These and probably all succulent forms are characterized by an exaggerated production of mucilages or pentosans, and have certain implied cycles of metabolism, including an incomplete

<sup>1</sup> Donaldson, H. The relation of myelin to the loss of water in the mammalian nervous system with advancing age. Proc. Nat. Acad. Sc., 2: 350. 1916. Hatai, S. Changes in the composition of the entire body of the albino rat during the life span. Amer. Jour. Anat., 1: 23. 1917.

<sup>2</sup> Ostwald, W. Ueber seitlichen Eigenschaften der Entwicklungsvorgänge, p. 49. 1908.

type of respiration which leaves large acid residues. These, constituting the total acidity of the cell-masses, may vary greatly during development and during the course of a day, and the actual acidity or hydrogen-ion concentration of the sap resulting from the buffer situation may also show a marked variation, but within narrower limits.

Although the development and maturation of fruits such as berries obviously includes a growth in which the total effect is one of practical maintenance or increase in the water-content, studies of their growth seem to be lacking. It was therefore planned to arrange a final series of experiments in which the enlargement of fruits with increasing dry weights and with small and more nearly constant dry weights should be measured. The walnut was taken to represent a structure with accumulating solid matter and the tomato for the other type.

The walnut consists of a thick, fleshy exocarp and a heavy endocarp which finally becomes hard and bony with the deposition of anhydrous wall material. The inclosed embryo also accumulates a large amount of condensed food-material. The tomato is a large globose berry in which deposition and thickening is confined to the small, hard seeds. The greater part of the fruit is a fleshy, watery pulp, which becomes more highly hydrated as progress is made toward maturity.

Nuts of *Juglans californica* var. *quercina* Babcock, of various sizes from 3 mm. in diameter to that approaching maturity, were borne on two trees in the garden at Carmel, California, in June 1918. Suitable supports being provided, the bearing lever of an auxograph was rested as lightly on the young nuts as was consistent with a clear record, and temperatures were taken by thin thermometers thrust into similar nuts or into young stems near the preparation. 15 nuts were measured for periods of 2 or 3 days, or for as long as 2 months in the case of No. 10.

Coincidentally with the measurements, an effort was made to determine the degree of saturation or hydration of the stems on which the nuts were borne. A well-defined "negative" pressure was detected in the basal branches of *Juglans major*, which was growing near the experimental tree. A basal branch 1.2 meters from the trunk gave a dry-looking surface when it was cut off.

A section of a similar branch about 8 mm. in thickness and 42 cm. long was cut away from another basal branch of the tree, the end of the detached portion quickly sealed with vaseline, and when all was in readiness the tip was excised and the cut thrust into water to ascertain the actual deficiency in this portion; 14 hours later a total of 6 c. c. of water had been absorbed and 24 hours later 8.5 c. c., which was a practical saturation, at a temperature of 18° to 20° C. The volume of the branch proved to be 35 c. c., so that the amount of water absorbed was 24 per cent of the total.

Sections of young internodes of *Juglans californica quercina* which had an average diameter of about 2.5 mm. were swelled in solutions as

below, then dried, and swelled again, with results as shown in table 119 at 16° C.:

TABLE 119.

Swelling of sections of stems of Juglans.	Fresh living.	After drying.
	<i>p. ct.</i>	<i>p. ct.</i>
Distilled water.....	10	34
Citric acid, 0.01 N.....	14	34
Potassium hydroxid, 0.01 M.....	13.2	34
Potassium nitrate, 0.01 M.....	12	32
(On basis of original thickness.)		

The unsatisfied water capacity of these sections taken from young terminal internodes was comparatively great, doubtless due in part to the constant drain of the active leaves they bore. The older wood, including that formed the previous year, showed an absorptive capacity of 22 per cent in water. It is from these older internodes that the nuts arise.

The nuts were highly turgid, exuded sap when cut into, and hence must have had a colloidal composition which acted to withdraw water from the stems, which were less highly hydrated. The soil was low in moisture-content at this time, as it had been 4 or 5 months without rain.

Tests of nuts 8 to 10 mm., from which tangential slices had been removed to give a uniform thickness of 7.5 mm., were made in July, and these swelled at temperatures of 17° to 20° C. in solutions as follows:

TABLE 120.

	<i>p. ct.</i>
Distilled water.....	1.4
Citric acid, 0.01 M.....	1.8
Potassium hydroxid, 0.01 M.....	1.4
Potassium nitrate, 0.01 M.....	2

A useful conception of the hydration conditions in the stems and fruits may be formed, if due weight is given to the measurements cited above. The woody branches of the previous year, on which both the leafy green twigs and those bearing the nuts are borne, had a relatively large deficiency in water, so that sections a few centimeters long absorbed about 20 to 25 per cent of their volume of distilled water in 24 hours at 20° C. No swelling test was made, but it is obvious that an enlargement of only a small fraction might be shown by this or any branch with a mature woody cylinder. The active green twigs still in a state of elongation arising from these branches had a swelling capacity of 10 per cent. The growing nuts arising from the drier stems exuded water from cut surfaces, the cotyledons being sacs of watery fluid, in contrast to the dry appearance of sections of the youngest internodes, and showed a swelling of less than 2 per cent and soon shrunk when placed in a cylin-

der of distilled water after being cut in halves. In a system of this kind any alteration of the conditions which would facilitate transpiration would have a differential effect on the older stems, the green leafy twigs, and the fruits. The loss from the stems would be affected least, since the bark would effectually prevent any notable increase in evaporation from the relatively dry woody tissues. The loss from the leafy twigs would of course tend to become greater and the deficit in both leaves and twigs would be increased and their absorbing power correspondingly increased. The outer integument of the nuts being still in an embryonic condition and being highly hydrated, the loss would reach a maximum rate, with the daily effect of causing a cancellation of enlargement beginning mid-forenoon at 20° to 22° C. and continuing until mid-afternoon, when a fall in temperature brought transpiration to a rate below that of accession from the stem.

A large percentage of the nuts which were placed under the auxograph lever were cast off at various stages of development by abscission of the stalk. The inciting causes of the anatomical change which results in abscission lie outside the scope of this article. It was noted, however, that it was preceded by a period in which the nut showed a shrinkage by day in the higher temperatures and lessened humidity, alternating with equalizing enlargements, at nights. Finally, an abrupt, rapid, and continuous shrinkage resulted in the separation of the stalk.

The general features of growth of these nuts may be illustrated by a résumé of history of No. 10, which was under continuous observation from July 15 to September 9, 1918, during which period of 56 days its diameter increased from 16 mm. to 26.5 mm. Of this, 2.25 mm. was gained in the first 5 days of cool, foggy weather. This effect was confirmed by the fact that a cessation or retardation occurred at midday and was most pronounced on hot, sunny days, suggesting a direct water-loss. In the week ending July 29 the total growth was an increase of 1.7 mm. This period was characterized by heavy fogs and mists in the forenoon, both the amount of shrinkage and rate of increase being lessened—an equalization to be ascribed in part to approaching maturity. The temperature taken from a thermometer thrust in a young branch of the thickness of the nut ranged from 13° to 22° C. The completion of the record of No. 10 was followed by cutting of the branch bearing it at a distance of 30 cm., placing the excised end in water, and arranging the entire preparation in the dark room at 17° C., with the nut under the bearing lever of the auxograph. Swelling continued for about 20 hours, after which shrinkage began, which rapidly accelerated (see fig. 48).

The general features of growth are also well illustrated by the following notes on No. 15, which was brought under observation when it was about 15 mm. in diameter and put under an auxograph ampli-

fyng 45 on August 3. Great daily variations in size, with a net total increase, were displayed every day. Usually enlargement could be detected between noon and 2 o'clock, which continued until 8 or 10 the following morning. If the sun rose clear, shrinkage began immediately. If the morning was foggy it would be delayed. Minor variations might be brought about by the shade of clouds, especially noticeable at noonday August 6 and to be seen at other times.

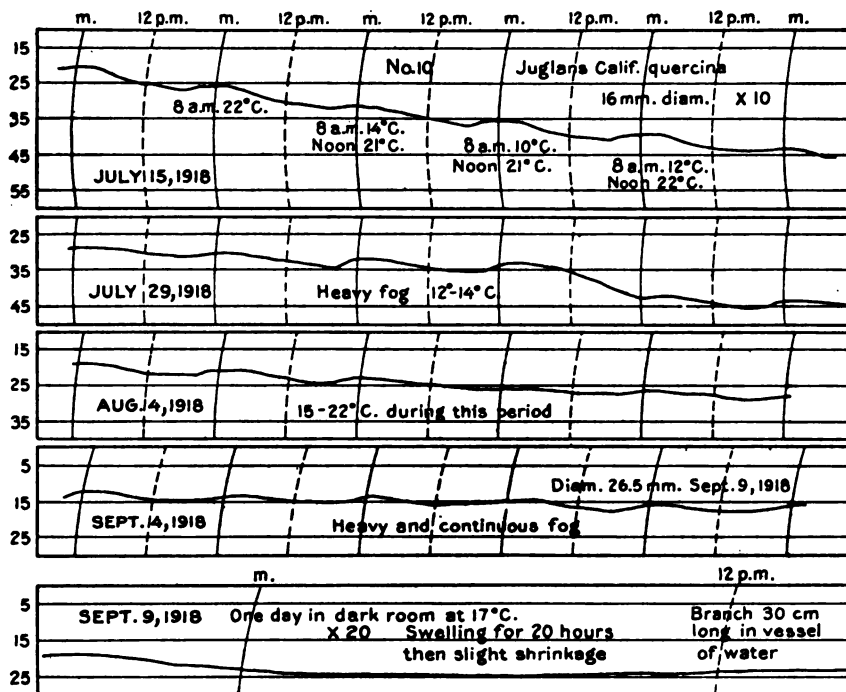

FIG. 48.—Variations in volume of nut of *Juglans* during 56 days. Enlargement is denoted by downward course of pen tracing, X 10. The lowermost section of the figure gives auxographic record of swelling of a nut in a dark room on a branch 30 cm. in length with the cut end in a vessel of water. Swelling for 20 hours occurred after shrinkage began as denoted by upward course of pen tracing.

After these facts were noted, experimental modifications were arranged. Temperatures were taken from a branch 16 mm. in thickness which were probably within a degree of that of the nut at all times. A screen was arranged to cut off the direct rays of the sun at midday, the nut being exposed for about 4 hours in the forenoon to direct illumination. The temperatures ranged from 14° to 25° C. The occurrence of fogs and of rain added to the variations in the conditions affecting transpiration. The shrinkage in the forenoon was abrupt and marked, being lessened on foggy days, and reaching an extreme of 4 mm. when the temperature rose from 14° to 25° C. in the 4 hours, while it was on no day less than one-fourth this amount. The increase varied from a minimum growth of less than 0.1 mm. on a cool, foggy



day to 0.7 mm. when shaded on August 6, and to a similar amount in a rain on September 11, at which time it was in an advanced state of development (fig. 49).

It is to be seen from the above that the fruit of the walnut in an environment favorable to its development exhibits daily variations in growth clearly attributable to the balance between transpiration and absorption. The nut in a growing condition has a high water-content and a small unsatisfied capacity, but its supply from the relatively dry stems must come slowly—so slowly that any marked increase in transpiration would overbalance the absorption by the nut and result in cessation of enlargement or even shrinkage.

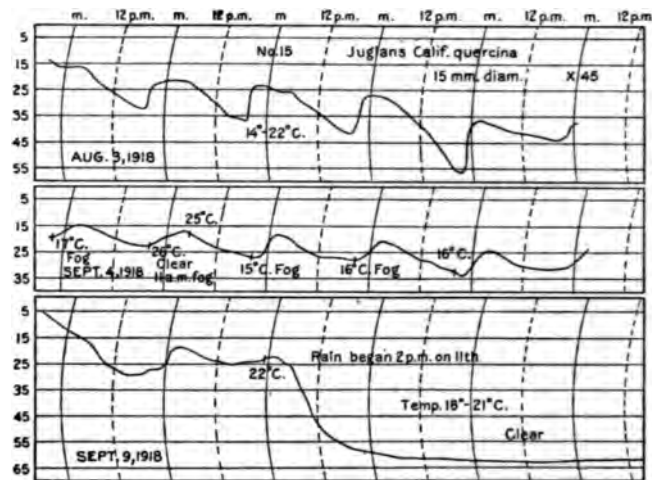

FIG. 49.—Variations in volume of a growing nut of *Juglans* 15 mm. in diameter at beginning for a period of 45 days. The marked acceleration under the conditions of high humidity and abundant water-supply are illustrated in the record beginning September 9. Retarding or shrinking effects of noonday temperature and low humidity and masking effects of fog are also illustrated.

The fruit of the tomato (*Lycopersicon*) presents features of water-content unlike any other organ the growth of which had been under observation in present studies. The most striking feature of this phase of the matter is that the proportion of solid material is higher in young fruits than in mature ones. In the determination of the proportions, first young fruits less than a week old were taken and 4 tomatoes with radial diameters of 14, 16, 17, and 18 mm. were found to weigh 14.650 grams. These were fragmented and placed in a beaker on a water-bath at about 100° C. for 48 hours, at which time the dry material remaining was 1.90 grams. From this it is to be seen that the young fruit contained 87 per cent of water and 13 per cent of dry material. A mature fruit of the same kind as those measured was 46 mm. in axial diameter and 58 mm. in radial diameter and weighed 93.050 grams. This was dried over water-bath for 2 days, at which time

8.400 grams remained. From this it is to be seen that the ripe fruit contained 91 per cent of water and 9 per cent of dry material. In fact, these fruits show a better parallel to the hydration reactions of the prepared biocolloids than any living material which has hitherto been examined for the purpose of estimating the value of the physical factors in growth.

A number of plants of the tomato were grown in suitable boxes of soil at a ranch in the Carmel Valley, and were in such a stage of development that young fruits were available at the Coastal Laboratory early in August 1918. Six plants in all were used and continuous records from fruits of an axial diameter of 3 to 4 mm. to maturity at 50 to 55 mm. were obtained. The fruits were oblate-spheroid in form and the auxograph was arranged to register increase in diameter nearly parallel to the axis in some cases and radially or at right angles to it in others. In addition to the other advantageous features of this material, the regular form and mode of growth made it possible to use the variations in diameter as a basis for calculating the changes in volume of the fruits taken as spheres.

Temperatures were taken by thrusting the thin bulbs of small thermometers into fruits near the one under measurement. The development of such fruits was but little affected by this wounding and the thermometers remained firmly in place, as in the fleshy joints of *Opuntia*, in the measurement of which this method was first practiced. The preparations stood in a well-ventilated glass-house and the soil around the roots was kept moist in accordance with the cultural requirements of these plants. The results may be best set forth by the description of the action of the several fruits measured.

No. 1 was placed in the greenhouse and a fruit 29 mm. in diameter was fixed on a block of hard cork in such position that it gave a radial bearing to the auxograph, which was set to amplify changes in volume by 5, on August 9. The record was kept continuously until September 18, at which time the radial diameter of the fruit was 51.5 mm. The fruit was turning yellow on September 16 and was showing fluctuations in volume comparable to those in No. 2, with which it was run in close comparison and under almost exactly the same conditions of moisture and temperature as recorded.

No. 2 was adjusted to the auxograph in the greenhouse on August 9, in such manner as to give modifications of the axial diameter, which at this time was about 27 mm. The record was continuous until September 18, at which time the diameter was 50.5 mm. This fruit, like No. 1, was beginning to turn yellow on September 16.

No. 3, 10 mm. in diameter, was adjusted to the auxograph to record variations in radial diameter on August 21, and a record was kept continuously with frequent notations of temperature and sunshine, etc. It is to be noted that 1, 2, and 3 were under equable temperatures,

19° to 20° C., and high relative humidity during the rainfall of September 11 and 12.

The fact that the greatest increase in growth occurs in fruits at diameters between 16 and 25 mm. in diameter, before half the final size is reached, is a point to which we shall recur in the discussion of growth in terms of volume. Thus, in No. 3 the increases in thickness weekly were as follows: 6 mm., 6.3 mm., 2.5 mm., 3.5 mm. (fig. 50).

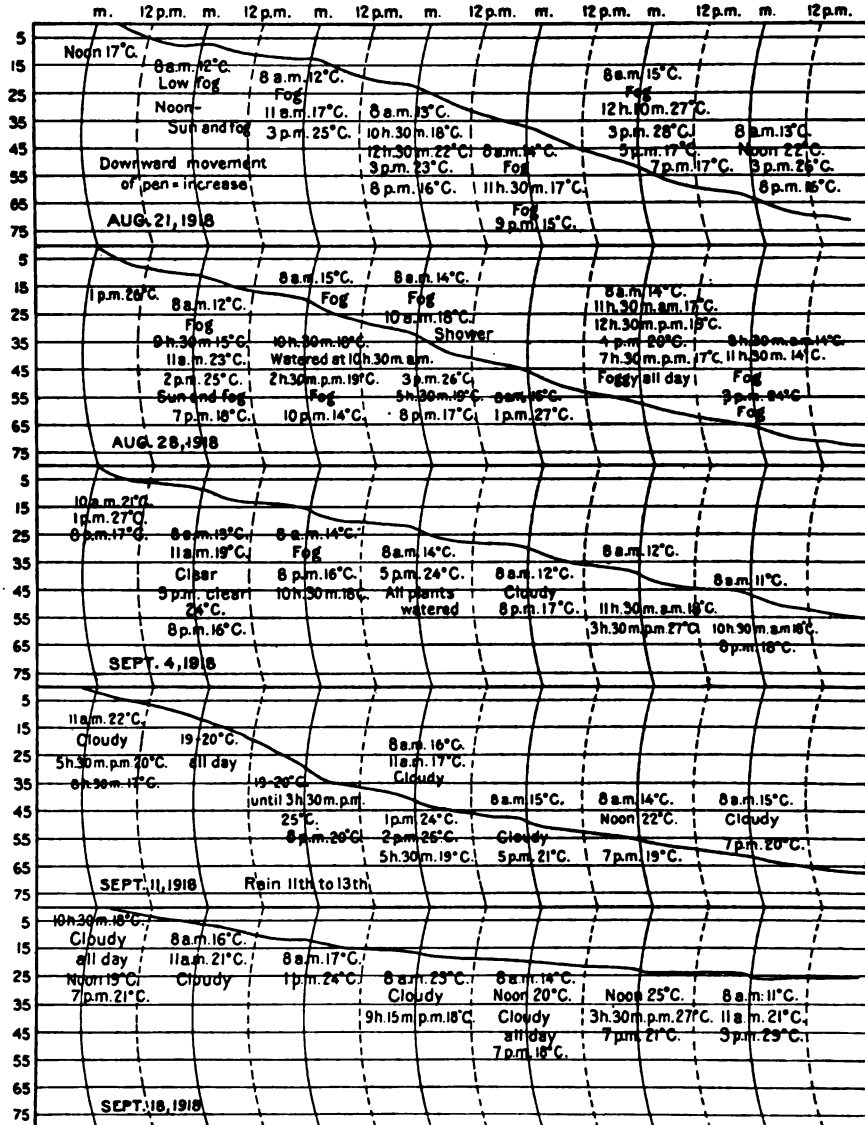

Fig. 50.—Variations in radial or transverse diameter of a tomato during development in 28 days. Increase is denoted by downward course of the auxographic tracing, and the direct effects of temperatures and relative humidity are illustrated by the record and the accompanying notations in the figure. Amplified 5 times on scale ruled to 5 mm. intervals.

If this method be followed it would at once be obvious that while the rate of increase in diameter would be a direct measurement, yet as the fruit increases as a globe the actual material added could be regarded as a shell on this globe. The rate in terms of volume would therefore be the amount of this shell to be calculated by finding the difference between the initial volume and the volume at the end of each period. The rate by direct measurement of diameter and by volume increases may be compared as in table 121, for periods of one week beginning on the date given.

TABLE 121.—Average daily rate of growth.

Date.	Diameter, millimeters.	Volume, cubic millimeters.
Aug. 9..	1.7	2,604
16..	1.1	2,513
21..	0.7	2,064
28..	0.4	1,373
Sept. 4..	0.28	976
11..	0.17	695

TABLE 122.

Date.	Diameter, millimeters.	Volume, cubic millimeters.
Aug. 9..	0.95	2,072
16..	0.7	1,852
21..	0.56	1,800
28..	0.3	660
Sept. 4..	0.2	508
11..	0.2	560

The rate on September 11 by direct measurement would appear to be one-tenth that of a month earlier, yet actually water and new material was being added at a rate equivalent to one-fourth of the earlier rate. The radial proportions would make the rate on August 21 not much more than 40 per cent of the rate on August 9, while the increase in volume was over 96 per cent. The rate in the week beginning August 28 would appear to be less than a fourth that by direct measurement on August 9, yet actually the increment of water and material is more than half that in the younger stage and smaller size.

A second plant with the auxograph arranged to take axial variations in the fruits which measured 33 mm. was arranged to run concurrently with No. 1 and under identical temperature and conditions of moisture. The daily rates of increase in diameter were as shown in table 122 for weeks beginning on the dates given.

Here again the actual course of growth as calculated in terms of volume shows that simple measurements of the thickness do not express the real values in growth of such organs.

The third test was made on a fruit taken at a much earlier stage at a diameter of 16 mm. with a transverse or radial bearing, the temperature and moisture conditions being similar to those of 1 and 2. The daily rate of increase was as shown in table 123 for the weeks beginning on the given dates.

The actual volume of this fruit at the close of the experiment was approximately 2,900 c. mm. and its growth had been followed for a period of 40 days. It is notable that in the earlier stage in the advance of the fruit from 20 to 26 mm. in diameter (August 21 to August 31), while the increase of the diameter seems constant, yet the actual

accession of material is very much greater. Then, in further development, the average increment to the diameter was smaller, yet the actual accession of material was greater (see September 4). Following this, the rate falling from 0.8 to 0.3 mm. daily, the accession decreases less than half. (See figs. 51 and 52.)

TABLE 123.

Date.	Diameter, millimeters.	Volume, cubic millimeters.
Aug. 21..	0.85	537
28..	0.85	851
Sept. 4..	0.64	885
11..	0.8	1,643
18..	0.3	564
25..	0.37	662

TABLE 124.

	20° C.		30° C.	
	Diam.	Volume.	Diam.	Volume.
	mm.	c. mm.	mm.	c. mm.
Sept. 1....	1	72	.....	.....
Sept. 7....	2	33	0.8	128
Sept. 14....	1.4	33	.3	91
Sept. 21....	0.08	9	.085	27

Attention was now directed to temperature effects as measured in this manner. Two plants were placed in chambers subjected to equivalent diffuse illumination and humidity. The fruits similar to those

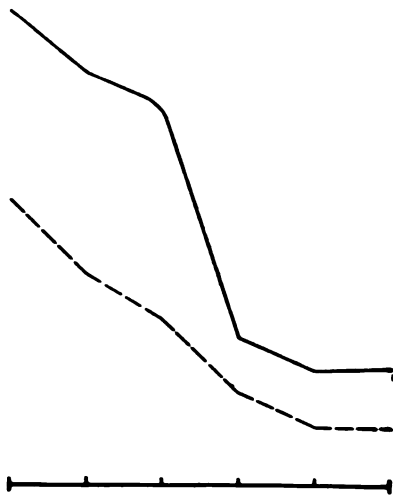

FIG. 51.—Diagram illustrating the course of growth of a tomato during the six weeks of its development. The broken line is plotted from the average daily rate of growth during each week, and the solid line from the calculated increases in volume.



FIG. 52.—Similar to fig. 51, but beginning at an earlier stage. The average daily rate is seen to form a graph which presents notable differences from the one plotted from variations in volume.

measured in one showed thermometer readings of 19° to 21° C. and in the other 29° to 31° C. The daily rates of axial increase were as shown in table 124 for the weeks beginning on the given dates.

The conditions under which both plants were grown were unfavorable to development, but it is to be noted that the rates of increase

sustained a changing relation as growth slackened. The enlargement of such highly watery fruits must be so largely a matter of diffusion and hydration that any formula expressive of the temperature relations of chemical transformation must be wide of the facts in many stages of development.

The record of growth of No. 3, which is given in full in figure 50, shows beyond question the effect of transpiration and water-loss on growth. As the daily temperatures of the fruits rose from 12° C. and 14° C. to 26° C. and 28° C., acceleration ensued up to a point where the rise caused a water-loss overbalancing the gain by hydration. Higher temperatures, therefore, did not facilitate or accelerate growth unless accompanied by high relative humidity. Thus the highest growth rates are those of midday and afternoon, with fog or showers. This is especially marked on the records of September 10, 11, 12, and 13, in which a 50-hour rainy period was anticipated and followed by high humidity. (See fig. 50.) It was not possible to increase the water-supply by watering the soil around the roots in such manner as to cancel the midday shrinkage or slackening in growth. One especially striking effect is that in which the rise in temperature consequent upon the cessation of the rain, from 20° to 25° C. at 3 p. m. on September 13, was followed by a lessened rate of growth. On the cloudy days growth was uniformly high. Similar effects were exhibited by a small fruit of a potato in a greenhouse at Tucson in May 1918.

The two types of fruits are seen to show a concordant behavior with respect to the balance between the water-supply and transpiration. A rise in temperature with accompanying lessened relative humidity had the effect of retarding or stopping growth or of producing an actual shrinkage in volume. The nut and the berry are both more highly hydrated or more watery than the stem through which their water-supply must be drawn. This was established by measurement in the walnut and is obvious with respect to the tomato and its stems.

A distinction must be made between the water-relations of a fruit and its stem and that which prevails between a parasite and its host, or between a swelling colloid and the solution in which it may be immersed. The water deficit of the stems as measured by swelling includes that of the entire structure. The fruits, however, receive their supply through special conduits which sustain only a mechanical relation to the other parts of the stem which may be active in its swelling. Such non-conducting tissues of course draw their supply from this system of conduits also, but it is highly probable that the disproportion between the water-content of the fruit and of the tracts in the stem from which it receives its supply is not so great as might be indicated by the measurements given. The hydration capacity of the fruits would be the resultant of many factors, including the pentosan-

protein ratio, the hydrogen-ion concentration, the action of salts, and the effect of the amino compounds.

The delicate balance between water-loss and absorption as revealed by measurements of growing organs of all kinds is very striking. The rate at which water is received is generally so little in excess of the transpiration that a rise of 10 to 15 degrees centigrade may extinguish the balance. At the same time, such rise in temperature may also result in a lessened hydration capacity, so that by the action of the acids at the higher temperature, water may theoretically be forced out of the colloidal complex.

It is plainly evident that growth consists of two fundamental features—hydration of the colloidal material of the plasma and the arrangement of additional material in colloidal structures with the entailed additional capacity for adsorbing water. The first may occur without the second, and increase in volume might occur in a pentosan-protein colloid at any time by the action of its own metabolic products, such as the hydrogen-ion concentration or the proportion of amino-compounds formed. Growth by accession of solid material without a corresponding absorption of water is characteristic of cell organs or walls, and such deposition of material can only result in changes in volume which would not be measurable by auxographic methods.

Hydration consists, in the first instance, of the union of molecules of water with the molecules of solid material in the colloidal masses, and it is this action which is entailed in the initial and almost instantaneous enlargement of dried sections when water is poured on them. No serious reason has yet been advanced, however, against the extension of the term to apply to the accompanying and subsequent adsorption of an indefinite number of molecules on the surfaces of the molecular aggregates. Cell-masses are already in an advanced stage of hydration, and all of the tests with living material are simply modifications of such a condition. The swelling of dried sections of plant tissue may include some chemical action, or some union of water with the solid material in definite proportions.

The manner in which hydration ensues, or rather the character of the process, will naturally depend upon the character of the cell colloids. If these are albuminous, swelling will be largely determined by the hydrogen-ion concentration of the solution. It also follows that any cell-organ or cell-mass which is dominantly proteinaceous will show such increases of hydration capacity with acidity, modified by other facts, including the presence of salts or bases.

These effects are modified or reversed in colloidal material which consists more largely of carbohydrate material. The pentosans represented by various gums and mucilages are abundant in plant cells, and these present some variety of composition and differences

in solubility or dispersibility. One group which may be illustrated by agar has a definitely limited swelling capacity under temperatures below 50° C. and other conditions, and of course is not soluble. Others, like the mucilages of *Opuntia* or acacia or tragacanth, are soluble, and when placed in water pass from a dry solid state to a complete solution. The solubility of protoplasm will depend upon the presence of these substances, as well as upon the albumins which may be present.

The ideal capacity for hydration and growth of any mass of protoplasm would be a resultant of the composition and proportions of its organic material and of the relation of the phases in which they occur. The theoretical maximum hydration of a carbohydrate-protein system is invariably modified by the nutrient salts adsorbed in its structure and by the products of unceasing metabolic changes, especially the transformations which are comprehended in respiration and which carry compounds through a stage in which acids are formed. These features, as influenced by temperature, determine the rate, daily course, and total expansion in growth. In addition, a certain amount of material is lost from the plant in the form of carbon dioxide, and, as has been emphasized on the preceding pages, the surface loss of water may on occasion be greater than the amount passing into the growing cell-masses. The above-mentioned processes and agencies affect the rate, course, and amount of growth.



## LITERATURE CITED.

- ASKENASY, E. Ueber die Temperature, welche Pflanzen im Sonnenlicht annehmen. *Bot. Zeitung*, 33: 441-2. 1875.
- BARRY, F. The influence of temperature upon chemical reactions in general. *Amer. Jour. Bot.*, 1: 203. 1914.
- BEIJERINCK, M. W. Ueber Emulsoidenbildung bei der Vermischung wasseriger Lösungen gewisser gelatinierendem Kolloide. *Zeitschrift f. Kolloid-Chem.*, 7: 16. 1910.
- BERMAN, N., and L. F. RETTGER. The influence of carbohydrates on the nitrogen metabolism of bacteria. *Jour. Bacter.*, 3: 389. 1918.
- BOROWIKOW, G. A. Ueber die Ursachen des Wachstums der Pflanzen. *Biochem. Zeitschr.*, 48: 230, and 50: 119. 1913.
- BROOKS, S. C. Permeability of cell-walls of *Allium*. *Botan. Gas.*, 64: 509. 1917.
- BROWN and TRELEASE. Alternate shrinkage and elongation of growing stems of *Cestrum nocturnum*. *Philip. Jour. of Science* 13: No. 6. *Bot.*, p. 353. Nov. 1918.
- CLARK, LOIS. Acidity of marine algae. *Puget Sound Marine Sta. Publ.* 1, No. 22. 1917.
- CONKLIN, E. G. Effects of centrifugal force on the structure and development of the eggs of *Crepidula*. *Jour. Exper. Zool.*, 22: 356-364. Feb. 1917.
- DACHNOWSKI, A. The effects of acid and alkaline solutions upon the water-relations and the metabolism of plants. *Amer. Jour. Bot.*, 1: 412-439. 1914.
- and GORMLEY. The physiological water requirement and the growth of plants in glycocoll solutions. *Amer. Jour. Bot.*, 1: 174-185. 1914.
- DAKIN, H. D. The catalytic action of amino-acids, etc., in effecting certain syntheses. *Jour. Biol. Chem.*, 7: 49-55. 1909.
- DENNY, F. E. Permeability of certain plant membranes to water. *Bot. Gazette*, 63: 373-397. 1917.
- . Permeability of membranes as related to their composition. *Bot. Gazette*, 63: 468-485. 1917.
- DONALDSON, H. The relation of myelin to the loss of water in the mammalian nervous system with advancing age. *Proc. Nat. Acad. Sci.*, 2: 350. 1916.
- FENN, W. O. Similarity in the behavior of protoplasm and gelatine. *Proc. Nat. Acad. Sci.*, 2: 539. 1916.
- FREE, E. E. Note on the swelling of gelatine and agar gels in solutions of sucrose and dextrose. *Science, n. s.*, 46: 142. 1917.
- . A colloidal hypothesis of protoplasmic permeability. *The Plant World*, 21: 141. 1918.
- FREUNDLICH, H. *Kapillarchemie; eine Darstellung der Chemie der Kolloide und verwandte Gebiete*, pages 504-511. 1909.
- GRAHAM, E. A., and H. T. GRAHAM. Retardation by sugars of diffusion by acids in gels. *Jour. Amer. Chem. Soc.*, 40: 1900. 1918.
- HAAS, A. R. The reaction of plant protoplasm. *Bot. Gazette*, 63: 232. 1917.
- HARDY, W. B. On the structure of cell protoplasm. *Jour. Physiol.*, 24: 158. 1899.
- HARVEY, R. B. Hardening processes in plants and developments from frost injury. *Jour. Agric. Res.*, 15: 83. 1918.
- HATAI, S. Changes in the composition of the entire body of the albino rat during the life span. *Amer. Jour. Anat.*, 1: 23. 1917.
- HEMPEL, JENNY. The buffer processes in the metabolism of succulent plants. *Compt. Rend. d. trav. d. Lab. Carlsberg*, 13: No. 1. 1917.
- HOFMEISTER, F. Die Betheiligung gelöster Stoffe an Quellungsvorgänge. *Archiv f. Exper. Pathol. u. Pharm.*, 27: 395, 1890, and 28: 210, 1891.
- KARSTEN, H. Die Einwirkung des Lichtes auf das Wachstums der Pflanzen. *Jena*. 1870.
- KITE, G. L. The physical properties of protoplasm of certain plant and animal cells. *Amer. Jour. Physiol.*, 32: 146 (especially pp. 161 and 162). 1913.
- KUNKEL, LOUIS OTTO. A study of the problem of water absorption. *Twenty-third Annual Report, Missouri Botanical Garden*, pp. 26-40. 1912.

- LLOYD, FRANCIS E. Colloidal phenomena in the protoplasm of pollen tubes. Report Dept. Bot. Research, Carnegie Inst. Wash. for 1917, Year Book No. 16. 1918.
- . The origin and nature of the mucilage in the cacti and in certain other plants. *Amer. Jour. of Bot.* 6:156. 1919.
- LOEB, J. The similarity of the action of salts upon the swelling of animal membranes and of powdered colloids. *Jour. Biol. Chem.*, 31:343. 1917.
- . Amphoteric colloids. I: Chemical influence of the hydrogen-ion concentration. *Jour. Gen. Physiol.*, 1:39. 1918.
- LONG, E. R. Growth and colloid hydration in cacti. *Botan. Gazette*, 59:No. 6. June 1915.
- . Acid accumulation and destruction in large succulents. *The Plant World*, 18:No. 10, 261. 1918.
- MACCALLUM, A. M. The distribution of potassium in animal and vegetable cells. *Jour. Physiol.*, 32:95. 1905.
- . Presidential address, Brit. Assoc. for Adv. of Sci., Report for 1910, 744.
- MACDOUGAL, D. T. The influence of etiolation upon chemical composition, in "The influence of light and darkness upon growth and development." *Mem. N. Y. Bot. Garden*, 2:300-305. 1903.
- . The Salton Sea: A study of the geography, the geology, the floristics, and ecology of a desert basin. *Carnegie Inst. Wash. Pub. No. 193.* 1914.
- . The experimental modification of germ-plasm. *Annals Mo. Bot. Garden*, 2:253-274., Feb.-Apr. 1915.
- . Mechanism and conditions of growth. *Mem. N. Y. Bot. Garden*, 6:5-26. 1916.
- . Imbibitional swelling of plants and colloidal mixtures. *Science*, n. s., 44:502-505. 1916.
- . The beginnings and physical basis of parasitism. *The Plant World*, 20:238. 1917.
- . The relation of growth and swelling of plants and biocolloids to temperature. *Proc. Soc. Exper. Biol. and Med.*, 15:48. 1917.
- . The effect of bog and swamp waters on swelling in plants and in biocolloids. *The Plant World*, 21:88-99. 1918.
- , and W. A. CANNON. The conditions of parasitism in plants. *Carnegie Inst. Wash. Pub. No. 129.* 1910.
- , H. M. RICHARDS, and H. A. SPOEHR. The basis of succulence in plants. *Botan. Gazette*, 67:405. 1919.
- , and H. A. SPOEHR. The behavior of certain gels useful in the interpretation of the action of plants. *Science*, n. s., 45:484-488. 1916.
- , ———. Growth and imbibition. *Proc. Amer. Phil. Soc.*, 56:289. 1917.
- , ———. The effects of acids and salts on biocolloids. *Science*, n. s., 46:269. 1917.
- , ———. The effect of organic acids and their amino-compounds on the hydration of agar and on a biocolloid. *Proc. Soc. Exper. Biol. and Med.*, 16:33. 1918.
- , ———. The origination of xerophytism. *The Plant World*, 21:245. 1919.
- , ———. The solution and fixation accompanying swelling and drying of biocolloids and plant tissues. *The Plant World*, 22:—. 1919.
- MATHEWS, A. P. *Physiological chemistry*, 2d ed. p. 211. 1916.
- MCCLENDON, J. F. The physical chemistry of vital phenomena, page 95. 1917.
- MCGEE, J. M. The effect of position on the temperature and dry weight of joints of *Opuntia*. *Rep. Dept. Bot. Research, Carnegie Inst. Wash. for 1916, Year Book No. 15.* Feb. 15, 1917.
- . The imbibitional swelling of marine algae. *The Plant World*, 21:13. 1918.
- OSTERHOUT, W. J. V. The permeability of living cells to salts in pure and balanced solutions. *Science*, n. s., 34:187-189. Aug. 11, 1911.
- . Nature of antagonism. *Science*, n. s., 41:255-256. 1915.
- . Some aspects of the temperature coefficients of life processes. *Jour. Biol. Chem.*, 32:No. 1. 1917.
- OSTWALD, W. Ueber zeitlichen Eigenschaften der Entwicklungs-vorgänge, page 49. 1906.
- , translated by M. FISCHER. An introduction to theoretical and applied colloid chemistry, pages 84-92. 1909.
- , and M. FISCHER. Theoretical and applied colloid chemistry. 1917.

- PALLADIN, W. Eiweissgehalt der grünen und der etiolirter Blätter. Ber. d. deut. Bot. Ges., 9: 191. 1891.
- . Transpiration als Ursache der Formänderung etiolirter Pflanzen. Ber. d. deut. Bot. Ges., 8: 364. 1890.
- PEARSON, H. H. W. Observations on the internal temperatures of *Euphorbia virosa* and *Aloe dichotoma*. Annals Bolus Herbarium, vol. 1, part 2. Nov. 1914.
- RIGG, G. B. Summary of bog theories. The Plant World, 19: 310. 1916.
- ROBERTSON, T. B. The physical chemistry of proteins. 1918.
- SCHIMPER, A. F. W. Die Indo-Malayscher Strandflora, page 142. 1891.
- SHREVE, E. B. An analysis of the causes of variations in the transpiring power of cacti. Physiol. Researches, 2: No. 13. Aug. 1916.
- . A thermo-electrical method for the determination of leaf temperature. Plant World, 22: 100. 1919. P. 118.
- SPOEHR, H. A. The pentose sugars in plant metabolism. The Plant World, 21: 365-379. 1917.
- . Carbohydrate economy of the cacti. Carnegie Inst. Wash. Pub. No. 287. 1919.
- STEWART, E. G. Mucilage or slime formation in the cacti. Bull. Torr. Bot. Club, 46: 157. 1919.
- STILES, WALTER, INGVAR JØRGENSEN. Studies in permeability. The swelling of plant tissue in water and its relation to temperature and various dissolved substances. Annals of Botany, 31: 415. 1917.
- , ———. Quantitative measurement of permeability. Botan. Gazette, 65: 526. 1918.
- SWARTZ, M. D. Nutrition investigations on the carbohydrates of lichens, algæ, and related substances. Tran. Conn. Acad. Arts and Sciences, 16: 247. 1911. P. 29.
- THODAY, D. On turgescence and the absorption of water by the cells of plants. New Phytologist, 17: 108. 1918.
- THOMPSON, D. A. W. Growth and form. 1917.
- TOTTINGHAM, W. E. A quantitative chemical and physiological study of nutrient solutions for plant cultures. Physiol. Res., 1: No. 4. May 1914.
- URSPRUNG, A. Die physikalischen Eigenschaften der Laubblätter. Bibliotheca Botanica, 12 (Heft 60), 68. 1903-4.
- WACHTER, W. Untersuchungen über den Austritt von Zucker aus den Zellen der Speicherorgane von *Allium cepa* und *Beta vulgaris*. Jahrb. f. wiss. Bot., 41: 165. 1905.
- ZSIGMONDY, R., translated by E. P. SPEAR. Chemistry of colloids, p. 222. 1917.

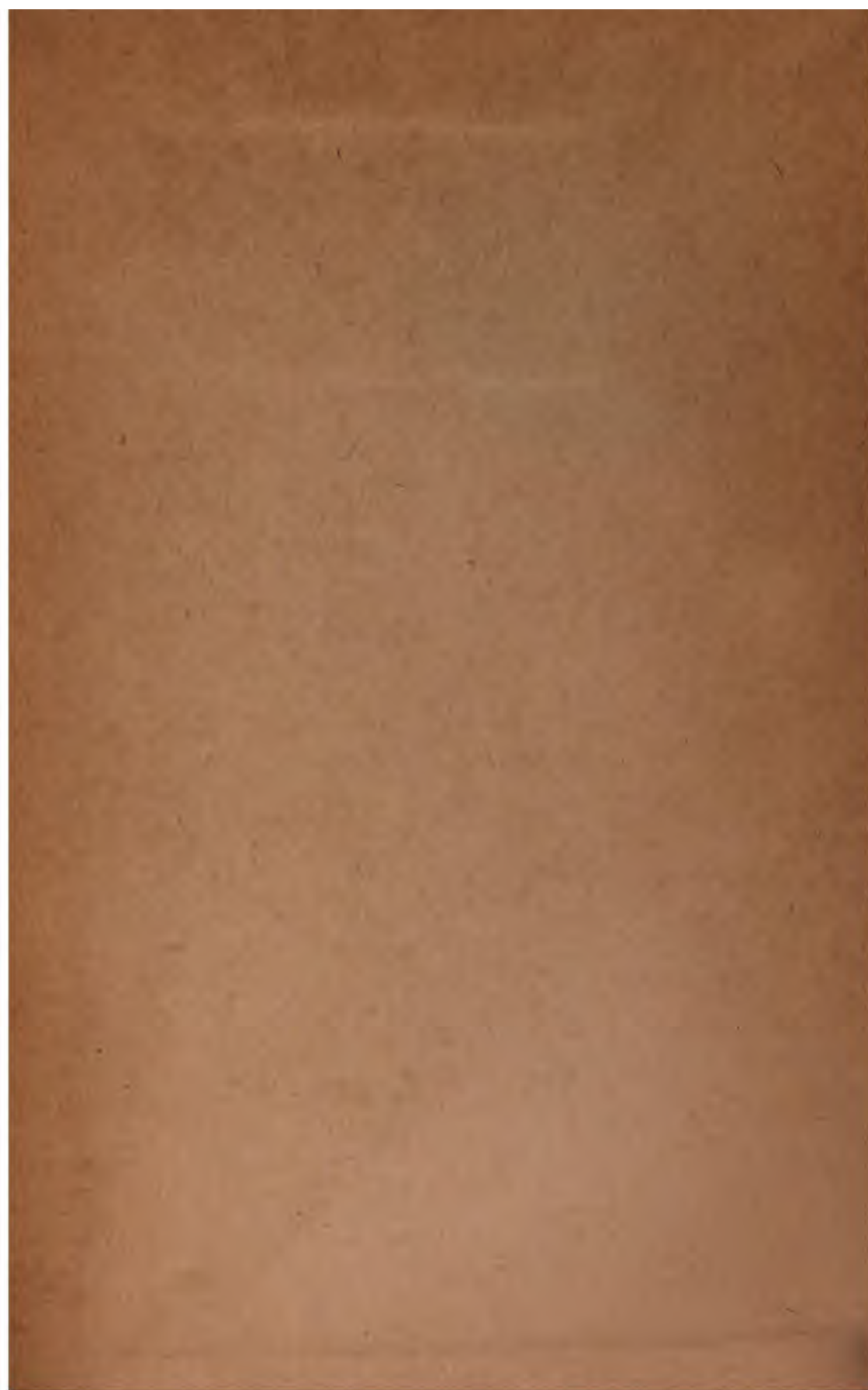

LANE MEDICAL LIBRARY

To avoid fine, this book should be returned on  
or before the date last stamped below.

--	--	--

A183 Carnegie institution of  
C28 Washington.  
no. 297 Publications 52250

1920 NAME	DATE DUE
<i>Kindy</i>	

